

STATE OF NORTH CAROLINA  
DEPARTMENT OF TRANSPORTATION  
HIGHWAY DIVISION 3  
**PROPOSAL**

**DATE AND TIME OF BID OPENING: NOVEMBER 1, 2012 AT 2:00 PM**

**CONTRACT ID: DC00044**

**WBS ELEMENT NO.: 3B.101011 and 3B.201012**

**COUNTY: BRUNSWICK**

**ROUTE NO.: VARIOUS**

**LOCATION: VARIOUS**

**TYPE OF WORK: REMOVAL OF EXISTING PIPE CULVERTS AND  
REPLACEMENT WITH ALUMINUM  
PIPE CULVERTS AND HEADWALLS.**

**NOTICE:**

ALL PROPOSERS SHALL COMPLY WITH ALL APPLICABLE LAWS REGULATING THE PRACTICE OF GENERAL CONTRACTING AS CONTAINED IN CHAPTER 87 OF THE GENERAL STATUTES OF NORTH CAROLINA WHICH REQUIRES THE PROPOSER TO BE LICENSED BY THE N.C. LICENSING BOARD FOR CONTRACTORS WHEN BIDDING ON ANY NON-FEDERAL AID PROJECT WHERE THE BID IS \$30,000 OR MORE, EXCEPT FOR CERTAIN SPECIALTY WORK AS DETERMINED BY THE LICENSING BOARD. PROPOSERS SHALL ALSO COMPLY WITH ALL OTHER APPLICABLE LAWS REGULATING THE PRACTICES OF ELECTRICAL, PLUMBING, HEATING AND AIR CONDITIONING AND REFRIGERATION CONTRACTING AS CONTAINED IN CHAPTER 87 OF THE GENERAL STATUTES OF NORTH CAROLINA. NOT WITHSTANDING THESE LIMITATIONS ON BIDDING, THE PROPOSER WHO IS AWARDED ANY PROJECT SHALL COMPLY WITH CHAPTER 87 OF THE GENERAL STATUTES OF NORTH CAROLINA FOR LICENSING REQUIREMENTS WITHIN 60 CALENDAR DAYS OF BID OPENING, REGARDLESS OF FUNDING SOURCES.

**BIDS WILL BE RECEIVED AS SHOWN BELOW:**

**BID BOND NOT REQUIRED**

**RETURN BIDS TO: NORTH CAROLINA DEPARTMENT OF TRANSPORTATION  
LLOYD G. ROYALL, JR.. PLS  
NCDOT DIVISION 3 OFFICE  
5501 BARBADOS BLVD.  
CASTLE HAYNE, NC 28429**

**PROPOSAL FOR THE CONSTRUCTION OF  
CONTRACT No. DC00044 IN BRUNSWICK COUNTY, NORTH CAROLINA**

**October 11, 2012**

**DEPARTMENT OF TRANSPORTATION, DIVISION THREE  
CASTLE HAYNE, NORTH CAROLINA**

The Bidder has carefully examined the location of the proposed work to be known as Contract No. **DC00044**; has carefully examined the plans and specifications, which are acknowledged to be part of the proposal, the special provisions, the proposal, the form of contract, and the forms of contract payment bond and contract performance bond; and thoroughly understands the stipulations, requirements and provisions. The undersigned bidder agrees to bound upon his execution of the bid and subsequent award to him by the Department in accordance with this proposal to provide the necessary contract payment bond and contract performance bond within fourteen days after the written notice of award is received by him. The undersigned Bidder further agrees to provide all necessary machinery, tools, labor, and other means of construction; and to do all the work and to furnish all materials, except as otherwise noted, necessary to perform and complete the said contract in accordance with *the 2012 Standard Specifications for Roads and Structures* by the dates(s) specified in the Project Special Provisions and in accordance with the requirements of the Engineer, and at the unit or lump sum prices, as the case may be, for the various items given on the sheets contained herein.

The Bidder shall provide and furnish all the materials, machinery, implements, appliances and tools, and perform the work and required labor to construct and complete State Highway Contract No. **DC00044** in **BRUNSWICK COUNTY**, for the unit or lump sum prices, as the case may be, bid by the Bidder in his bid and according to the proposal, plans, and specifications prepared by said Department, which proposal, plans, and specifications show the details covering this project, and hereby become a part of this contract.

The published volume entitled *North Carolina Department of Transportation, Raleigh, Standard Specifications for Roads and Structures, January 2012* with all amendments and supplements thereto, is by reference incorporated into and made a part of this contract; that, except as herein modified, all the construction and work included in this contract is to be done in accordance with the specifications contained in said volume, and amendments and supplements thereto, under the direction of the Engineer.

If the proposal is accepted and the award is made, the contract is valid only when signed either by the Contract Officer or such other person as may be designated by the Secretary to sign for the Department of Transportation. The conditions and provisions herein cannot be changed except over the signature of the said Contract Officer.

The quantities shown in the itemized proposal for the project are considered to be approximate only and are given as the basis for comparison of bids. The Department of Transportation may increase or decrease the quantity of any item or portion of the work as may be deemed necessary or expedient.

An increase or decrease in the quantity of an item will not be regarded as sufficient ground for an increase or decrease in the unit prices, nor in the time allowed for the completion of the work, except as provided for the contract.

**TABLE OF CONTENTS**

**PROJECT SPECIAL PROVISIONS..... 5**

GENERAL: .....5

PUBLIC ADVERTISEMENT: .....5

CONTRACT TIME AND LIQUIDATED DAMAGES: .....5

INTERMEDIATE CONTRACT TIME NUMBER 1 AND LIQUIDATED DAMAGES:.....5

INTERMEDIATE CONTRACT TIME NUMBER 2 AND LIQUIDATED DAMAGES:.....6

BANKRUPTCY: .....6

BIDS: .....6

CLAIMS FOR ADDITIONAL COMPENSATION OR EXTENSION OF TIME: .....6

CONTRACT PAYMENT AND PERFORMANCE BOND: .....6

CONTRACTOR CLAIM SUBMITTAL FORM: .....7

DEFAULT OF CONTRACT: .....7

EROSION, SILTATION, AND POLLUTION CONTROL:.....7

MATERIALS AND TESTING: .....7

PREQUALIFICATION TO BID ON POC’S: .....7

SAFETY AND ACCIDENT PROTECTION: .....8

UTILITY CONFLICTS: .....8

WORKERS’ COMPENSATION INSURANCE: .....8

TRAFFIC CONTROL: .....8

WORK ZONE SIGNING:.....11

STABILIZATION REQUIREMENTS:.....13

SEEDING AND MULCHING:.....13

CRIMPING STRAW MULCH: .....14

PROSECUTION OF WORK: .....15

POSTED WEIGHT LIMITS:.....15

MINORITY BUSINESS ENTERPRISE AND WOMEN BUSINESS ENTERPRISE  
(DIVISIONS): .....15

SUBSURFACE INFORMATION:.....27

LOCATING EXISTING UNDERGROUND UTILITIES: .....28

MAINTENANCE OF THE PROJECT:.....28

COOPERATION BETWEEN CONTRACTORS:.....28

GIFTS FROM VENDORS AND CONTRACTORS: .....28

EROSION AND SEDIMENT CONTROL/STORMWATER CERTIFICATION:.....29

PERMANENT VEGETATION ESTABLISHMENT:.....34

PROCEDURE FOR MONITORING BORROW PIT DISCHARGE:.....34

EMPLOYMENT:.....35

DAMAGE TO EXISTING PAVEMENT, BASE, SUBGRADE AND PROPOSED  
PAVEMENT: .....36

DRIVEWAYS AND PRIVATE PROPERTY: .....36

LITTER PICK-UP: .....36

NOTIFICATION OF OPERATIONS: .....36

PLAN, DETAIL AND QUANTITY ADJUSTMENTS:.....36

PRECONSTRUCTION CONFERENCE: .....36

PROSECUTION AND PROGRESS: .....36

UTILITY COORDINATION:.....37

NOTES TO CONTRACTOR:.....38

SHOULDER AND FILL SLOPE MATERIAL:.....38

ASPHALT PAVEMENTS - SUPERPAVE:.....	38
ASPHALT BINDER CONTENT OF ASPHALT PLANT MIXES: .....	39
ASPHALT PLANT MIXTURES: .....	39
ASPHALT PATCHING.....	39
FINAL SURFACE TESTING NOT REQUIRED: .....	39
MATERIALS: .....	40
SELECT MATERIAL, CLASS III, TYPE 3: .....	41
COIR FIBER MAT:.....	42
WATTLES WITH POLYACRYLAMIDE (PAM):.....	43
PERMITS .....	45
PIPE REMOVAL .....	46
GRADING.....	46
PIPE AND HEADWALL (INCL. ASSEMBLY AND INSTALLATION) .....	46
DEWATERING.....	47
UTILITY RELOCATIONS .....	47
<b><u>STANDARD SPECIAL PROVISION .....</u></b>	<b><u>49</u></b>
AVAILABILITY OF FUNDS – TERMINATION OF CONTRACTS: .....	49
NCDOT GENERAL SEED SPECIFICATION FOR SEED QUALITY:.....	49
ERRATA .....	51
PLANT AND PEST QUARANTINES: .....	52
MINIMUM WAGES: .....	53
ON-THE-JOB TRAINING: .....	54
<b><u>VICINITY MAPS .....</u></b>	<b><u>57</u></b>
<b><u>STRUCTURE DRAWINGS.....</u></b>	<b><u>63</u></b>
<b><u>GENERAL ALUMINUM STRUCTURE REQUIREMENTS.....</u></b>	<b><u>69</u></b>
<b><u>NCDOT APPROVED PIPE AND HEADWALL VENDORS .....</u></b>	<b><u>71</u></b>
<b><u>PIPE INFORMATION.....</u></b>	<b><u>72</u></b>
<b><u>TYPICAL SECTION.....</u></b>	<b><u>73</u></b>
<b><u>BYPASS PUMPING TYPICAL.....</u></b>	<b><u>74</u></b>
<b><u>EXECUTION OF BID.....</u></b>	<b><u>75</u></b>
<b><u>LETTER OF INTENT.....</u></b>	<b><u>83</u></b>
<b><u>LISTING OF MB &amp; WB SUBCONTRACTORS.....</u></b>	<b><u>84</u></b>
<b><u>BID FORM.....</u></b>	<b><u>85</u></b>

# PROJECT SPECIAL PROVISIONS

## GENERAL:

This contract is for the Removal of Existing Pipe Culverts and Replacement with Aluminum Pipe Culverts and Headwalls. All work and materials shall be in accordance with the provisions of the General Guidelines of this contract, the Project Special Provisions, the North Carolina Department of Transportation Standard Specifications for Roads and Structures 2012, the North Carolina Department of Transportation Roadway Standards Drawings, and the current edition of the Manual of Uniform Traffic Control Devices (MUTCD).

The Contractor shall keep himself fully informed of all Federal, State and local laws, ordinances, and regulations, and shall comply with the provisions of Section 107 of the Standard Specifications.

## PUBLIC ADVERTISEMENT:

There will NOT be a Pre-Bid Conference for this project. Plans and Proposal packages must be obtained by visiting: <http://www.ncdot.org/doh/operations/division3/> and clicking on "Bid Opportunities and Recent Bid Results".

## CONTRACT TIME AND LIQUIDATED DAMAGES:

(12-18-07)

108

SP1 G07 B

The date of availability for this contract is the date the Contractor begins work but not before **January 7, 2013**, except that work in jurisdictional waters and wetlands shall not begin until a meeting between NCDOT, Regulatory Agencies, and the Contractor is held as stipulated in the permits contained elsewhere in this proposal. This delay in availability has been considered in determining the contract time for this project.

The completion date for this contract is **August 30, 2013**.

Except where otherwise provided by the contract, observation periods required by the contract will not be a part of the work to be completed by the completion date and/or intermediate contract times stated in the contract. The acceptable completion of the observation periods that extend beyond the final completion date shall be a part of the work covered by the performance and payment bonds.

The liquidated damages for this contract are **Five Hundred Dollars (\$500.00)** per calendar day. These liquidated damages will not be cumulative with any liquidated damages which may become chargeable under Intermediate Contract Time Number 1. At the preconstruction conference the Contractor shall declare his expected date for beginning work. Should the Contractor desire to revise this date after the preconstruction conference, he shall notify the Engineer in writing at least thirty (30) days prior to the revised date.

## INTERMEDIATE CONTRACT TIME NUMBER 1 AND LIQUIDATED DAMAGES:

(12-18-07) (Rev. 2-21-12)

108

SP1 G13 B

Except for that work required under the Project Special Provisions entitled *Planting, Reforestation* and/or *Permanent Vegetation Establishment*, included elsewhere in this proposal, the Contractor will be required to complete all work included in this contract and shall place and maintain traffic on same.

The date of availability for this intermediate contract time is the date of availability of the contract. The completion date for this intermediate contract time is **May 31, 2013**.

The liquidated damages for this intermediate contract time are **Five Hundred Dollars (\$500.00)** per calendar day.

Upon apparent completion of all the work required to be completed by this intermediate date, a final inspection will be held in accordance with Article 105-17 and upon acceptance, the Department will assume responsibility for the maintenance of all work except *Planting, Reforestation* and/or *Permanent Vegetation Establishment*. The Contractor will be responsible for and shall make corrections of all damages to the completed roadway caused by his planting operations, whether occurring prior to or after placing traffic through the project.

**INTERMEDIATE CONTRACT TIME NUMBER 2 AND LIQUIDATED DAMAGES:**

The contractor shall be limited to three (3) weeks of road closure per site. All work requiring a road closure shall be completed during this time.

**The liquidated damages for this intermediate contract time are Five Hundred Dollars (\$500.00) per calendar day.**

**BANKRUPTCY:**

The Department of Transportation, at its option, may terminate the contract upon filing by the Contractor of any petition for protection under the provisions of the Federal Bankruptcy Act.

**BIDS:**

**In accordance with GS 136-28.1(b), if the total bid amount of the contract exceeds \$1,200,000, the bid will not be considered for award.**

**CLAIMS FOR ADDITIONAL COMPENSATION OR EXTENSION OF TIME:**

Any claims for additional compensation and/or extensions of the completion date shall be submitted to the Division Engineer with detailed justification within thirty (30) days after receipt of the final invoice payment. The failure of the Contractor to submit the claim(s) within thirty days shall be a bar to recovery.

**CONTRACT PAYMENT AND PERFORMANCE BOND:**

A performance bond in the amount of one hundred percent (100%) of the contract amount, conditioned upon the faithful performance of the contract in accordance with specifications and conditions of the contract is required. Such bond shall be solely for the protection of the North Carolina Department of Transportation and the State of North Carolina.

A payment bond in the amount of one hundred percent (100%) of the contract amount, conditioned upon the prompt payment for all labor or materials for which the Contractor, or his subcontractors, is liable is required. The payment bond shall be solely for the protection of persons or firms furnishing materials or performing labor for this contract for which the Contractor is liable.

**The successful bidder, within fourteen (14) days after notice of award, shall provide the Department with a contract payment bond and a contract performance bond each in an amount equal to 100 percent of the amount of the contract.**

**CONTRACTOR CLAIM SUBMITTAL FORM:**

(9-16-08)

SP1G140

If the Contractor elects to file a written claim or requests an extension of contract time, it shall be submitted on the *Contractor Claim Submittal Form (CCSF)* available through the Construction Unit or: [http://ncdot.org/doh/operations/dp\\_chief\\_eng/constructionunit/formsmanuals/](http://ncdot.org/doh/operations/dp_chief_eng/constructionunit/formsmanuals/).

**DEFAULT OF CONTRACT:**

The Department of Transportation shall have the right to declare a default of contract for breach by the Contractor of any material term or condition of the contract. Default of contract shall be in accordance with the terms, conditions, and procedures of Article 108-9 of the Standard Specifications.

**EROSION, SILTATION, AND POLLUTION CONTROL:**

The Contractor shall exercise every reasonable precaution and take all necessary measures throughout the life of the project to prevent erosion, siltation, and pollution in accordance with Section 107-12 of the Standard Specifications.

**MATERIALS AND TESTING:**

The Engineer reserves the right to perform all sampling and testing in accordance with Section 106 of the Standard Specifications and the Department's "Materials and Test Manual." However the Engineer may reduce the frequency of sampling and testing where he deems it appropriate for the project under construction.

The Contractor shall furnish the applicable certifications and documentation for all materials as required by the Standard Specifications. Material, which is not properly certified, will not be accepted.

Delivery tickets for all asphalt material shall be furnished in accordance with Section 106-7 of the Standard Specifications and shall include the following information:

NCDOT WBS Element	Plant Location
Date	Truck Number
Time issued	Contractor's Name
Type of Material	Public weighmaster's stamp or number
Gross weight	Public weighmaster's signature or initials in ink
Tare Weight	Job mix formula numbers
Net weight of material	

**PREQUALIFICATION TO BID ON POC'S:**

Beginning **July 1, 2009**, any firm that wishes to perform work on Division Purchase Order Contracts as either the prime contractor or as a subcontractor on the project must be prequalified for the type of work they wish to perform. Firms that wish to bid on these projects as the prime contractor must be prequalified prior to submitting a bid. Firms that wish to perform as a subcontractor to the prime contractor must be prequalified prior to beginning work on the project.

For the purposes of prequalification, any firm that is currently prequalified as a prime or a subcontractor on central let projects for the appropriate work codes is considered eligible to work and/or bid on Purchase Order Contracts as long as other items such as bonding and license requirements for the contract are met.

Information regarding the requirements to become prequalified as a Purchase Order Contract contractor, including the application to become prequalified if you are not already prequalified, can be found at the following website: <http://www.ncdot.org/business/howtogetstarted/>

**SAFETY AND ACCIDENT PROTECTION:**

In accordance with Article 107-21 of the Standard Specifications, the Contractor shall comply with all applicable Federal, State, and local laws, ordinances, and regulations governing safety, health, and sanitation, and shall provide all safeguards, safety devices, and protective equipment, and shall take any other needed actions, on his own responsibility that are reasonably necessary to protect the life and health of employees on the job and the safety of the public, and to protect property in connection with the performance of the work covered by the contract.

**UTILITY CONFLICTS:**

The Contractor shall adhere to all applicable regulations and follow accepted safety procedures when working in the vicinity of utilities in order to insure the safety of construction personnel and the public.

**WORKERS' COMPENSATION INSURANCE:**

Pursuant to N.C.G.S. § 97-19, all contractors of the Department of Transportation are, prior to beginning services, required to show proof of coverage issued by a workers' compensation insurance carrier, or a certificate of compliance issued by the Department of Insurance for self-insured subcontractors stating that it has complied with N.C.G.S. § 97-93 irrespective of whether subcontractors have regularly in service fewer than three employees in the same business within the State of North Carolina, and subcontractors shall be hereinafter liable under the Workers' Compensation Act for payment of compensation and other benefits to its employees for any injury or death due to an accident arising out of and in the course of performance of the work insured by the subcontractor.

**TRAFFIC CONTROL:**

(01-17-12)

RWZ-1

Maintain traffic in accordance with Divisions 10, 11 and 12 of the *2012 Standard Specifications* and the following provisions:

Install Work Zone Advance Warning Signs in accordance with Standard Drawing No. 1101.01 of the *2012 Roadway Standard Drawings* prior to beginning any other work. Use a lane closure or slow moving operation to complete the work, as necessary, unless otherwise indicated (refer to Standard Drawing No. 1101.02, 1101.11, 1110.01, 1110.02 and 1130.01 of the *2012 Roadway Standard Drawings*). Use a moving operation only if the minimum speed maintained at all times is 3 mph with no stops that narrow or close a lane of travel. If the moving operation is progressing slower than 3 mph at any time, install a lane closure. Maintain the existing traffic pattern at all times, except in the immediate work zone where lane closures are allowed as determined by the Engineer.

Refer to attached details and Standard Drawing No. 1101.01, 1101.02, 1101.03, 1101.04, 1101.05, 1101.11, 1110.01, 1110.02, 1115.01, 1130.01, 1135.01, 1145.01, 1150.01, 1165.01, 1170.01 and 1180.01 of the *2012 Roadway Standard Drawings* when closing a lane of travel in a stationary work zone such as pavement patching resurfacing, or pavement marking removal. Properly ballasted cones may be used instead of drums for lane closures during daylight hours. However, drums are required for the upstream taper portion of lane closures in all applications. The stationary work zone shall be a maximum of 3 miles in length at any given time unless otherwise directed by the Engineer. A pilot vehicle operation may be used in conjunction with flaggers and the appropriate pilot vehicle warning



signing as directed by the Engineer. During periods of construction inactivity, return the traffic pattern to the existing alignment and remove or cover any work zone signs. When covering work zone signs, use an opaque material that prevents reading of the sign at night by a driver using high beam headlights. Use material, which does not damage the sign sheeting. Replace any obliterated markings as required by other sections of the *2012 Standard Specifications* and the Engineer.

When personnel and/or equipment are working on the shoulder adjacent to an undivided facility and within 5 feet of an open travel lane, close the nearest open travel lane using Standard Drawing No. 1101.02 of the *2012 Roadway Standard Drawings* unless the work area is protected by barrier or guardrail. When personnel and/or equipment are working on the shoulder, adjacent to a divided facility and within 10 feet of an open travel lane, close the nearest open travel lane using Standard Drawing No. 1101.02 of the *2012 Roadway Standard Drawings* unless the work area is protected by barrier or guardrail. When personnel and/or equipment are working within a lane of travel of an undivided or divided facility, close the lane according to the traffic control plans, *2012 Roadway Standard Drawings* or as directed by the Engineer. Conduct the work so that all personnel and/or equipment remain within the closed travel lane. Do not work simultaneously, on both sides of an open travel way, within the same location, on a two-lane, two-way road. Do not perform work involving heavy equipment within 15 feet of the edge of travel way when work is being performed behind a lane closure on the opposite side of the travel way. Perform work only when weather and visibility conditions allow safe operations as directed by the Engineer.

Do not exceed a difference of 2 inches in elevation between open lanes of traffic for nominal lifts of 1.5 inches. Install advance warning UNEVEN LANES signs (W8-11 at 48" X 48") 500 feet in advance and a minimum of once every half mile throughout the uneven area.

Backfill at a 6:1 slope up to the edge and elevation of existing pavement in areas adjacent to an open travel lane that has an edge of pavement drop-off as follows:

- (A) Drop-off that exceeds 2 inches on roadways with posted speed limits of 45 mph or greater.
- (B) Drop-off that exceeds 3 inches on roadways with posted speed limit less than 45 mph.

Backfill the unacceptable drop-off with suitable compacted material, as approved by the Engineer, at no expense to the Department. This work is not considered part of shoulder reconstruction.

When utilizing a slow-moving operation for such items as pavement marking placement, pavement marker installation and pesticide spraying, the slow moving operation caravan shall consist, as a minimum, of the vehicles and devices shown on the Moving Operation Caravan Details as shown on Standard Drawing No. 1101.02, sheets 11, 12 and 13 of the *2012 Roadway Standard Drawings*. Traffic cones may be used when necessary to provide additional protection of wet pavement markings. Ballast all traffic cones so they will not be blown over by traffic.

Failure to comply with the following requirements will result in a suspension of all other operations:

1. Before working on ANY MAP, the Contractor shall submit a written construction sequence for traffic control and construction lighting for ALL MAPS to the Engineer at the first pre-construction meeting and the sequence must be approved before closing a lane of traffic. The Contractor and Engineer will coordinate with the Traffic Management Unit at 919-773-2800 or Traffic Services for additional traffic control guidance, as necessary.
2. Coordinate the installation of items required by the contract documents and resurfacing operations such that these operations are completed in the order as agreed upon with the Engineer at the first pre-construction meeting. Refer to the Provisions, Typicals and Details unless otherwise directed by the Engineer.

3. Once the Contractor has started work at a location, the Contractor should prosecute the work in a continuous and uninterrupted manner from the time he begins the work until completion and final acceptance unless determined otherwise by the Engineer.
4. Obtain written approval of the Engineer before working in more than one location or setting up additional lane closures.
5. Mainline pavement shall not be left milled, unmarked or uneven at the end of a paving season.
6. Contractor shall mill and pave lanes in an order such that water shall not accumulate.

Notify the Engineer 48 hours before milling or resurfacing will interfere with the existing Signal Loops. Loops may need to be placed in milled surface before resurfacing occurs. Coordinate all signal loop operations with the Engineer.

Notify the Engineer 15 consecutive calendar days before resurfacing a bridge or its approaches. Patch and make repairs to bridge surface and its approaches before resurfacing occurs. Coordinate all operations on the bridge and its approaches with the Engineer.

Notify the Engineer 48 hours before resurfacing the areas of existing pavement that require patching. Patch these areas before resurfacing occurs. Allow full depth asphalt patching to cool to the point of supporting traffic without displacement or rutting before reopening closed lane. Coordinate the resurfacing operations of the patched areas with the Engineer.

During a resurfacing only operation, bring all newly resurfaced lanes to the same elevation within 72 hours for nominal lifts of 1.5 inches or less of asphalt course and by the end of each work day for nominal lifts of greater than 1.5 inches of asphalt course.

For partial or wheel track milling operations on two-way, two-lane facilities, mill and pave back by the end of each work day. For partial or wheel track milling operations on multi-lane facilities, the lane being milled may be left closed and paved back within 72 hours.

The following options are available during Resurfacing and milling operations on two-way, two-lane facilities when the entire roadway or entire lane is to be milled:

- (A) Mill a single lane and pave back by the end of each work day.
- (B) Mill the entire width of roadway and pave back within 72 hours.

The following options are available during Resurfacing and milling operations on multi-lane facilities when all lanes or a single lane in one direction are to be milled:

- (A) Mill a single lane and pave back by the end of each work day.
- (B) Mill the entire width of pavement for all lanes to be milled in any direction daily and pave back within 72 hours.

When resurfacing facilities with ramps, resurface the ramp and gore area of the ramp as agreed upon with the Engineer. Place the transverse joint on the ramp at the terminal point of the gore unless the ramp is being resurfaced beyond this limit.

Slope the pavement at the beginning and ending of the daily milling operation as directed by the Engineer. Sweep and remove all milled material from the roadway as soon as the daily milling operation is completed. Continue milling operations until the particular section of roadway being milled is complete. Remove any existing pavement adjacent to the milled area that has been damaged and replace with patch material as directed by the Engineer.

Maintain vehicular access in accordance with Article 1101-14 of the *2012 Standard Specifications* using suitable backfill material approved by the Engineer.

Operate equipment and conduct operations in the same direction as the flow of traffic. Do not cross medians with equipment, except at properly designated interchanges.

Review and record the existing pavement markings and markers prior to resurfacing. Use the record of existing pavement markings and markers in accordance with the *2012 Roadway Standard Drawings* to re-establish the proposed pavement markings and markers unless otherwise directed by the Engineer.

Provide appropriate lighting in accordance with Section 1413 of the *2012 Standard Specifications*.

Remove existing pavement markers in preparation for paving. Repair any pavement damage due to existing pavement marker removal prior to the end of the work day. Dispose of existing pavement markers as directed by the Engineer. No direct payment will be made for this work, as it will be incidental to the paving operation.

Payment will be made for the traffic control items that have been included in the contract. No direct payment will be made for providing other traffic control as required herein, as the cost of same will be considered incidental to the work being paid for under those various traffic control items that have been included. Where the Contractor maintains traffic as required herein but no specific pay items have been included in the contract, all associated costs will be considered incidental to the work being paid for under the various items in the contract.

### **WORK ZONE SIGNING:**

(01-17-12)

RWZ-3

#### **Description**

Install and maintain signing in accordance with Divisions 11 and 12 of the *2012 Standard Specifications*, the *2012 Roadway Standard Drawings* and the following provisions:

Furnish, install, maintain and remove advance warning work zone signs and any required lane closure signing.

Furnish, install and maintain general work zone warning signs for resurfacing and milling such as ROUGH ROAD (W8-8 at 48" X 48") (for milling only), UNEVEN LANES (W8-11 at 48" X 48"), LOW SHOULDER (W8-9 at 48" X 48"), LOW / SOFT SHOULDER (DOT No. 16-79860 at 48" X 48"), UNMARKED PAVEMENT AHEAD (DOT No. 116087130 at 48" X 48") and DO NOT PASS (R4-1 at 24" X 30"). When construction is completed in any area of the project, relocate signs to the next work site, as directed by the Engineer. Remove these signs at the completion of the project.

All work zone signs may be portable.

## **Construction Methods**

### **(A) General**

Install all warning work zone signs before beginning work on a particular map. If signs are installed three days prior to the beginning of work on a particular map, cover the signs until the work begins. Install each work zone warning sign separately and not on the same post or stand with any other sign except where an advisory speed plate or directional arrow is used.

### **(B) Advance Warning Work Zone Signs**

Install advance warning work zone signs in accordance with Standard Drawing No. 1101.01, 1101.02 and 1110.01 of the *2012 Roadway Standard Drawings* prior to beginning of work and remove upon final completion of the project. If there is a period of construction inactivity longer than two weeks, remove or cover advance warning work zone signs. Uncover advance warning work zone signs no more than 3 days before work resumes. All other operations could be suspended upon failure to comply with the above requirements. Such suspended operations would not be resumed until the above requirements are fulfilled.

### **(C) Lane Closure Work Zone Signs**

Install any required lane closure signing needed during the life of the project in accordance with the Standard Drawing No. 1101.02, 1101.11 and 1110.02 of the *2012 Roadway Standard Drawings*.

### **(D) General Work Zone Warning Signs**

Install general work zone warning signs for resurfacing and milling such as ROUGH ROAD (W8-8 at 48" X 48") (for milling only), UNEVEN LANES (W8-11 at 48" X 48"), LOW SHOULDER (W8-9 at 48" X 48") and LOW / SOFT SHOULDER (W8-9B at 48" X 48") at 1 mile intervals starting at a minimum of 500 feet in advance of the condition for both directions of travel (undivided roadways only) and at any other points determined by the Engineer.

Install the LOW SHOULDER (W8-9 at 48" X 48") or LOW / SOFT SHOULDER (DOT No. 16-79860 at 48" X 48") signs prior to any resurfacing in an area where shoulder construction will be performed.

Install general work zone warning signs such as UNMARKED PAVEMENT AHEAD (DOT No. 116087130 at 48" X 48") and DO NOT PASS (R4-1 at 24" X 30") alternately at 1/2 mile intervals starting at a minimum of 500 feet in advance of the condition for both directions of travel (undivided roadways only) and at any other points determined by the Engineer. Install signs prior to the obliteration of any pavement markings.

**Measurement and Payment**

Payment will be made for the work zone signing items that have been included in the contract. No direct payment will be made for providing other work zone signing as required herein, as the cost of same will be considered incidental to the work being paid for under those various work zone signing items that have been included. Where the Contractor provides work zone signing as required herein but no specific pay items have been included in the contract, all associated costs will be considered incidental to the work being paid for under the various items in the contract.

**STABILIZATION REQUIREMENTS:**

(11-4-11)

S-2A

Stabilization for this project shall comply with the time frame guidelines as specified by the NCG-010000 general construction permit effective August 3, 2011 issued by the North Carolina Department of Environment and Natural Resources Division of Water Quality. Temporary or permanent ground cover stabilization shall occur within 7 calendar days from the last land-disturbing activity, with the following exceptions in which temporary or permanent ground cover shall be provided in 14 calendar days from the last land-disturbing activity:

- Slopes between 2:1 and 3:1, with a slope length of 10 ft. or less
- Slopes 3:1 or flatter, with a slope of length of 50 ft. or less
- Slopes 4:1 or flatter

The stabilization timeframe for High Quality Water (HQW) Zones shall be 7 calendar days with no exceptions for slope grades or lengths. High Quality Water Zones (HQW) Zones are defined by North Carolina Administrative Code 15A NCAC 04A.0105 (25). Temporary and permanent ground cover stabilization shall be achieved in accordance with the provisions in this contract and as directed.

**SEEDING AND MULCHING:**

**(East Crimp)**

The kinds of seed and fertilizer, and the rates of application of seed, fertilizer, and limestone, shall be as stated below. During periods of overlapping dates, the kind of seed to be used shall be determined. All rates are in pounds per acre.

All Roadway Areas

**March 1 - August 31**

50# Tall Fescue  
 10# Centipede  
 25# Bermudagrass (hulled)  
 500# Fertilizer  
 4000# Limestone  
 10# Millet

**September 1 - February 28**

50# Tall Fescue  
 10# Centipede  
 35# Bermudagrass (unhulled)  
 500# Fertilizer  
 4000# Limestone  
 25# Choose ONE of the Following  
 Rye Grain,  
 Wheat FFR 555, or  
 Roane Wheat

## Waste and Borrow Locations

### March 1 - August 31

75#	Tall Fescue
25#	Bermudagrass (hulled)
500#	Fertilizer
4000#	Limestone

### September 1 - February 28

75#	Tall Fescue
35#	Bermudagrass (unhulled)
500#	Fertilizer
4000#	Limestone

Note: 50# of Bahiagrass may be substituted for either Centipede or Bermudagrass only upon Engineer's request.

## Approved Tall Fescue Cultivars

2 <sup>nd</sup> Millennium	Duster	Magellan	Rendition
Avenger	Endeavor	Masterpiece	Scorpion
Barlexas	Escalade	Matador	Shelby
Barlexas II	Falcon II, III, IV & V	Matador GT	Signia
Barrera	Fidelity	Millennium	Silverstar
Barrington	Finesse II	Montauk	Southern Choice II
Biltmore	Firebird	Mustang 3	Stetson
Bingo	Focus	Olympic Gold	Tarheel
Bravo	Grande II	Padre	Titan Ltd
Cayenne	Greenkeeper	Paraiso	Titanium
Chapel Hill	Greystone	Picasso	Tomahawk
Chesapeake	Inferno	Piedmont	Tacer
Constitution	Justice	Pure Gold	Trooper
Chipper	Jaguar 3	Prospect	Turbo
Coronado	Kalahari	Quest	Ultimate
Coyote	Kentucky 31	Rebel Exeda	Watchdog
Davinci	Kitty Hawk	Rebel Sentry	Wolfpack
Dynasty	Kitty Hawk 2000	Regiment II	
Dominion	Lexington	Rembrandt	

On cut and fill slopes 2:1 or steeper Centipede shall be applied at the rate of 5 pounds per acre and add 20# of Sericea Lespedeza from January 1 - December 31.

Fertilizer shall be 10-20-20 analysis. A different analysis of fertilizer may be used provided the 1-2-2 ratio is maintained and the rate of application adjusted to provide the same amount of plant food as a 10-20-20 analysis and as directed.

All areas seeded and mulched shall be tacked with asphalt. Crimping of straw in lieu of asphalt tack shall not be allowed on this project.

### **CRIMPING STRAW MULCH:**

Crimping shall be required on this project adjacent to any section of roadway where traffic is to be maintained or allowed during construction. In areas within six feet of the edge of pavement, straw is to be applied and then crimped. After the crimping operation is complete, an additional application of straw shall be applied and immediately tacked with a sufficient amount of undiluted emulsified asphalt.

Straw mulch shall be of sufficient length and quality to withstand the crimping operation.

Crimping equipment including power source shall be subject to the approval of the Engineer providing that maximum spacing of crimper blades shall not exceed 8".

**PROSECUTION OF WORK:**

(7-1-95) (Rev. 8-21-12)

108

SP1 G15R

The Contractor will be required to prosecute the work in a continuous and uninterrupted manner from the time he begins the work until completion and final acceptance of the project. The Contractor will not be permitted to suspend his operations except for reasons beyond his control or except where the Engineer has authorized a suspension of the Contractor's operations in writing.

In the event that the Contractor's operations are suspended in violation of the above provisions, the sum of \$ 500.00 will be charged the Contractor for each and every calendar day that such suspension takes place. The said amount is hereby agreed upon as liquidated damages due to extra engineering and maintenance costs and due to increased public hazard resulting from a suspension of the work. Liquidated damages chargeable due to suspension of the work will be additional to any liquidated damages that may become chargeable due to failure to complete the work on time.

**POSTED WEIGHT LIMITS:**

(7-1-95) (Rev. 8-21-12)

107

SP1 G 24R

The Contractor's attention is directed to the fact that many Primary and Secondary Roads and bridges are posted with weight limits less than the legal limit. Do not exceed the posted weight limits in transporting materials and/or equipment to the projects, unless otherwise indicated below. Make a thorough examination of all projects and haul routes and be prepared to discuss them at the Preconstruction Conference.

**MINORITY BUSINESS ENTERPRISE AND WOMEN BUSINESS ENTERPRISE**

**(DIVISIONS):**

(10-16-07)(Rev. 1-17-12)

102-15(J)

SP1 G67

**Description**

The purpose of this Special Provision is to carry out the North Carolina Department of Transportation's policy of ensuring nondiscrimination in the award and administration of contracts financed in whole or in part with State funds.

**Definitions**

*Additional MBE/WBE Subcontractors* - Any MBE/WBE submitted at the time of bid that will not be used to meet either the MBE or WBE goal. No submittal of a Letter of Intent is required.

*Committed MBE/WBE Subcontractor* - Any MBE/WBE submitted at the time of bid that is being used to meet either the MBE or WBE goal by submission of a Letter of Intent. Or any MBE or WBE used as a replacement for a previously committed MBE or WBE firm.

*Contract Goals Requirement* - The approved MBE and WBE participation at time of award, but not greater than the advertised contract goals for each.

*Goal Confirmation Letter* - Written documentation from the Department to the bidder confirming the Contractor's approved, committed MBE and WBE participation along with a listing of the committed MBE and WBE firms.

*Manufacturer* - A firm that operates or maintains a factory or establishment that produces on the premises, the materials or supplies obtained by the Contractor.

*MBE Goal* - A portion of the total contract, expressed as a percentage, that is to be performed by committed MBE subcontractor(s).

*Minority Business Enterprise (MBE)* - A firm certified as a Disadvantaged Minority-Owned Business Enterprise through the North Carolina Unified Certification Program.

*Regular Dealer* - A firm that owns, operates, or maintains a store, warehouse, or other establishment in which the materials or supplies required for the performance of the contract are bought, kept in stock, and regularly sold to the public in the usual course of business. A regular dealer engages in, as its principal business and in its own name, the purchase and sale or lease of the products in question. A regular dealer in such bulk items as steel, cement, gravel, stone, and petroleum products need not keep such products in stock, if it owns and operates distribution equipment for the products. Brokers and packagers are not regarded as manufacturers or regular dealers within the meaning of this section.

*North Carolina Unified Certification Program (NCUCP)* - A program that provides comprehensive services and information to applicants for MBE/WBE certification. The MBE/WBE program follows the same regulations as the federal Disadvantaged Business Enterprise (DBE) program in accordance with 49 CFR Part 26.

*United States Department of Transportation (USDOT)* - Federal agency responsible for issuing regulations (49 CFR Part 26) and official guidance for the DBE program.

*WBE Goal* - A portion of the total contract, expressed as a percentage, that is to be performed by committed WBE subcontractor(s).

*Women Business Enterprise (WBE)* - A firm certified as a Disadvantaged Women-Owned Business Enterprise through the North Carolina Unified Certification Program.

### **Forms and Websites Referenced in this Provision**

*Payment Tracking System* - On-line system in which the Contractor enters the payments made to MBE and WBE subcontractors who have performed work on the project.  
<https://apps.dot.state.nc.us/Vendor/PaymentTracking/>

*DBE-IS Subcontractor Payment Information* - Form for reporting the payments made to all MBE/WBE firms working on the project. This form is for paper bid projects only.  
<http://www.ncdot.org/doh/forms/files/DBE-IS.xls>

*RF-1 MBE/WBE Replacement Request Form* - Form for replacing a committed MBE or WBE.  
[https://apps.dot.state.nc.us/\\_includes/download/external.html?pdf=http%3A//www.ncdot.gov/doh/forms/files/RF-1.pdf](https://apps.dot.state.nc.us/_includes/download/external.html?pdf=http%3A//www.ncdot.gov/doh/forms/files/RF-1.pdf)



SAF *Subcontract Approval Form* - Form required for approval to sublet the contract.  
[http://www.ncdot.org/doh/operations/dp\\_chief\\_eng/constructionunit/saf.xls](http://www.ncdot.org/doh/operations/dp_chief_eng/constructionunit/saf.xls)

JC-1 *Joint Check Notification Form* - Form and procedures for joint check notification. The form acts as a written joint check agreement among the parties providing full and prompt disclosure of the expected use of joint checks.

[https://apps.dot.state.nc.us/\\_includes/download/external.html?pdf=http%3A//www.ncdot.gov/doh/forms/files/JC-1.pdf](https://apps.dot.state.nc.us/_includes/download/external.html?pdf=http%3A//www.ncdot.gov/doh/forms/files/JC-1.pdf)

*Letter of Intent* - Form signed by the Contractor and the MBE/WBE subcontractor, manufacturer or regular dealer that affirms that a portion of said contract is going to be performed by the signed MBE/WBE for the amount listed at the time of bid.

<http://www.ncdot.org/doh/preconstruct/ps/contracts/letterofintent.pdf>

*Listing of MBE and WBE Subcontractors Form* - Form for entering MBE/WBE subcontractors on a project that will meet this MBE and WBE goals. This form is for paper bids only.

<http://www.ncdot.gov/doh/preconstruct/ps/word/MISC3.doc>

*Subcontractor Quote Comparison Sheet* - Spreadsheet for showing all subcontractor quotes in the work areas where MBEs and WBEs quoted on the project. This sheet is submitted with good faith effort packages.

[http://www.ncdot.gov/business/ocs/goodfaith/excel/Ex\\_Subcontractor\\_Quote\\_Comparison.xls](http://www.ncdot.gov/business/ocs/goodfaith/excel/Ex_Subcontractor_Quote_Comparison.xls)

## **MBE and WBE Goal**

The following goals for participation by Minority Business Enterprises and Women Business Enterprises are established for this contract:

(A) Minority Business Enterprises 2%

- (1) *If the MBE goal is more than zero*, the Contractor shall exercise all necessary and reasonable steps to ensure that MBEs participate in at least the percent of the contract as set forth above as the MBE goal.
- (2) *If the MBE goal is zero*, the Contractor shall make an effort to recruit and use MBEs during the performance of the contract. Any MBE participation obtained shall be reported to the Department.

(B) Women Business Enterprises 1%

- (1) *If the WBE goal is more than zero*, the Contractor shall exercise all necessary and reasonable steps to ensure that WBEs participate in at least the percent of the contract as set forth above as the WBE goal.
- (2) *If the WBE goal is zero*, the Contractor shall make an effort to recruit and use WBEs during the performance of the contract. Any WBE participation obtained shall be reported to the Department.

## Directory of Transportation Firms (Directory)

Real-time information is available about firms doing business with the Department and firms that are certified through NCUCP in the Directory of Transportation Firms. Only firms identified in the Directory as MBE and WBE certified shall be used to meet the MBE and WBE goals respectively. The Directory can be found at the following link. <https://partner.ncdot.gov/VendorDirectory/default.html>

The listing of an individual firm in the directory shall not be construed as an endorsement of the firm's capability to perform certain work.

## Listing of MBE/WBE Subcontractors

At the time of bid, bidders shall submit all MBE and WBE participation that they anticipate to use during the life of the contract. Only those identified to meet the MBE goal and the WBE goal will be considered committed, even though the listing shall include both committed MBE/WBE subcontractors and additional MBE/WBE subcontractors. Any additional MBE/WBE subcontractor participation submitted at the time of bid will be used toward overall race-neutral goals. Only those firms with current MBE and WBE certification at the time of bid opening will be acceptable for listing in the bidder's submittal of MBE and WBE participation. The Contractor shall indicate the following required information:

**Blank forms will not be deemed to represent zero participation.** Bids submitted that do not have MBE and WBE participation indicated on the appropriate form will not be read publicly during the opening of bids. The Department will not consider these bids for award and the proposal will be rejected.

- (A) *If either the MBE or WBE goal is more than zero,*
- (1) Bidders, at the time the bid proposal is submitted, shall submit a listing of MBE/WBE participation, including the names and addresses on *Listing of MBE and WBE Subcontractors* contained elsewhere in the contract documents in order for the bid to be considered responsive. Bidders shall indicate the total dollar value of the MBE and WBE participation for the contract.
  - (2) If bidders have no MBE or WBE participation, they shall indicate this on the *Listing of MBE and WBE Subcontractors* by entering the word "None" or the number "0." This form shall be completed in its entirety.
  - (3) The bidder shall be responsible for ensuring that the MBE/WBE is certified at the time of bid by checking the Directory of Transportation Firms. If the firm is not certified at the time of the bid-letting, that MBE's or WBE's participation will not count towards achieving the corresponding goal.
- (B) *If either the MBE or WBE goal is zero,* bidders, at the time the bid proposal is submitted, shall enter the word "None"; or the number "0"; or if there is participation, add the value on the *Listing of MBE and WBE Subcontractors* contained elsewhere in the contract documents.

## **MBE or WBE Prime Contractor**

When a certified MBE or WBE firm bids on a contract that contains MBE and WBE goals, the firm is responsible for meeting the goals or making good faith efforts to meet the goals, just like any other bidder. In most cases, a MBE or WBE bidder on a contract will meet one of the goals by virtue of the work it performs on the contract with its own forces. However, all the work that is performed by the MBE or WBE bidder and any other similarly certified subcontractors will count toward the goal. The MBE or WBE bidder shall list itself along with any MBE or WBE subcontractors, if any, in order to receive credit toward the goals.

For example, on a proposed contract, the WBE goal is 10%, and the MBE goal is 8%. A WBE bidder puts in a bid where they will perform 40% of the contract work and have a WBE subcontractor which will perform another 5% of the work. Together the two WBE firms submit on the *Listing of MBE and WBE Subcontractors* a value of 45% of the contract which fulfills the WBE goal. The 8% MBE goal shall be obtained through MBE participation with MBE certified subcontractors or documented through a good faith effort. It should be noted that you cannot combine the two goals to meet an overall value. The two goals shall remain separate.

MBE/WBE prime contractors shall also follow Sections A or B listed under *Listing of MBE/WBE Subcontractors* just as a non-MBE/WBE bidder would.

## **Written Documentation – Letter of Intent**

The bidder shall submit written documentation for each MBE/WBE that will be used to meet the MBE and WBE goals of the contract, indicating the bidder's commitment to use the MBE/WBE in the contract. This documentation shall be submitted on the Department's form titled *Letter of Intent*.

The documentation shall be received in the office of the Engineer no later than 12:00 noon of the sixth calendar day following opening of bids, unless the sixth day falls on Saturday, Sunday or an official state holiday. In that situation, it is due in the office of the Engineer no later than 12:00 noon on the next official state business day.

If the bidder fails to submit the Letter of Intent from each committed MBE and WBE to be used toward the MBE and WBE goals, or if the form is incomplete (i.e. both signatures are not present), the MBE/WBE participation will not count toward meeting the MBE/WBE goal. If the lack of this participation drops the commitment below either the MBE or WBE goal, the Contractor shall submit evidence of good faith efforts for the goal not met, completed in its entirety, to the Engineer no later than 12:00 noon of the eighth calendar day following opening of bids, unless the eighth day falls on Saturday, Sunday or an official state holiday. In that situation, it is due in the office of the Engineer no later than 12:00 noon on the next official state business day.

## **Submission of Good Faith Effort**

If the bidder fails to meet or exceed either the MBE or the WBE goal, the apparent lowest responsive bidder shall submit to the Department documentation of adequate good faith efforts made to reach that specific goal(s).

One complete set and five copies of this information shall be received in the office of the Engineer no later than 12:00 noon of the sixth calendar day following opening of bids, unless the sixth day falls on

Saturday, Sunday or an official state holiday. In that situation, it is due in the office of the Engineer no later than 12:00 noon on the next official state business day.

Note: Where the information submitted includes repetitious solicitation letters, it will be acceptable to submit a representative letter along with a distribution list of the firms that were solicited. Documentation of MBE/WBE quotations shall be a part of the good faith effort submittal. This documentation may include written subcontractor quotations, telephone log notations of verbal quotations, or other types of quotation documentation.

### **Consideration of Good Faith Effort for Projects with MBE/WBE Goals More Than Zero**

Adequate good faith efforts mean that the bidder took all necessary and reasonable steps to achieve the goal which, by their scope, intensity, and appropriateness, could reasonably be expected to obtain sufficient MBE/WBE participation. Adequate good faith efforts also mean that the bidder actively and aggressively sought MBE/WBE participation. Mere *pro forma* efforts are not considered good faith efforts.

The Department will consider the quality, quantity, and intensity of the different kinds of efforts a bidder has made. Listed below are examples of the types of actions a bidder will take in making a good faith effort to meet the goals and are not intended to be exclusive or exhaustive, nor is it intended to be a mandatory checklist.

- (A) Soliciting through all reasonable and available means (e.g. attendance at pre-bid meetings, advertising and/or written notices through the use of the NCDOT Directory of Transportation Firms) the interest of all certified MBEs/WBEs who have the capability to perform the work of the contract. The bidder must solicit this interest within at least 10 days prior to bid opening to allow the MBEs/WBEs to respond to the solicitation. Solicitation shall provide the opportunity to MBEs/WBEs within the Division and surrounding Divisions where the project is located. The bidder must determine with certainty if the MBEs/WBEs are interested by taking appropriate steps to follow up initial solicitations.
- (B) Selecting portions of the work to be performed by MBEs/WBEs in order to increase the likelihood that the MBE and WBE goals will be achieved. This includes, where appropriate, breaking out contract work items into economically feasible units to facilitate MBE/WBE participation, even when the prime contractor might otherwise prefer to perform these work items with its own forces.
- (C) Providing interested MBEs/WBEs with adequate information about the plans, specifications, and requirements of the contract in a timely manner to assist them in responding to a solicitation.
- (D) (1) Negotiating in good faith with interested MBEs/WBEs. It is the bidder's responsibility to make a portion of the work available to MBE/WBE subcontractors and suppliers and to select those portions of the work or material needs consistent with the available MBE/WBE subcontractors and suppliers, so as to facilitate MBE/WBE participation. Evidence of such negotiation includes the names, addresses, and telephone numbers of MBEs/WBEs that were considered; a description of the information provided regarding the plans and specifications for the work selected for subcontracting; and evidence as to why additional agreements could not be reached for MBEs/WBEs to perform the work.

- (2) A bidder using good business judgment would consider a number of factors in negotiating with subcontractors, including MBE/WBE subcontractors, and would take a firm's price and capabilities as well as contract goals into consideration. However, the fact that there may be some additional costs involved in finding and using MBEs/WBEs is not in itself sufficient reason for a bidder's failure to meet the contract MBE or WBE goals, as long as such costs are reasonable. Also, the ability or desire of a prime contractor to perform the work of a contract with its own organization does not relieve the bidder of the responsibility to make good faith efforts. Bidding contractors are not, however, required to accept higher quotes from MBEs/WBEs if the price difference is excessive or unreasonable.
- (E) Not rejecting MBEs/WBEs as being unqualified without sound reasons based on a thorough investigation of their capabilities. The bidder's standing within its industry, membership in specific groups, organizations, or associates and political or social affiliations (for example, union vs. non-union employee status) are not legitimate causes for the rejection or non-solicitation of bids in the bidder's efforts to meet the project goal.
- (F) Making efforts to assist interested MBEs/WBEs in obtaining bonding, lines of credit, or insurance as required by the recipient or bidder.
- (G) Making efforts to assist interested MBEs/WBEs in obtaining necessary equipment, supplies, materials, or related assistance or services.
- (H) Effectively using the services of available minority/women community organizations; minority/women contractors' groups; Federal, State, and local minority/women business assistance offices; and other organizations as allowed on a case-by-case basis to provide assistance in the recruitment and placement of MBEs/WBEs. Contact within 7 days from the bid opening NCDOT's Business Development Manager in the Business Opportunity and Work Force Development Unit to give notification of the bidder's inability to get MBE or WBE quotes.
- (I) Any other evidence that the bidder submits which shows that the bidder has made reasonable good faith efforts to meet the MBE and WBE goal.

In addition, the Department may take into account the following:

- (1) Whether the bidder's documentation reflects a clear and realistic plan for achieving the MBE and WBE goals.
- (2) The bidders' past performance in meeting the MBE and WBE goals.
- (3) The performance of other bidders in meeting the MBE and WBE goals. For example, when the apparent successful bidder fails to meet the goals, but others meet it, you may reasonably raise the question of whether, with additional reasonable efforts the apparent successful bidder could have met the goals. If the apparent successful bidder fails to meet the MBE and WBE goals, but meets or exceeds the average MBE and WBE participation obtained by other bidders, the Department may view this, in conjunction with other factors, as evidence of the apparent successful bidder having made a good faith effort.

If the Department does not award the contract to the apparent lowest responsive bidder, the Department reserves the right to award the contract to the next lowest responsive bidder that can satisfy to the Department that the MBE and WBE goals can be met or that an adequate good faith effort has been made to meet the MBE and WBE goals.

### **Non-Good Faith Appeal**

The Engineer will notify the contractor verbally and in writing of non-good faith. A contractor may appeal a determination of non-good faith made by the Goal Compliance Committee. If a contractor wishes to appeal the determination made by the Committee, they shall provide written notification to the Engineer. The appeal shall be made within 2 business days of notification of the determination of non-good faith.

### **Counting MBE/WBE Participation Toward Meeting MBE/WBE Goals**

#### **(A) Participation**

The total dollar value of the participation by a committed MBE/WBE will be counted toward the contract goal requirements. The total dollar value of participation by a committed MBE/WBE will be based upon the value of work actually performed by the MBE/WBE and the actual payments to MBE/WBE firms by the Contractor.

#### **(B) Joint Checks**

Prior notification of joint check use shall be required when counting MBE/WBE participation for services or purchases that involves the use of a joint check. Notification shall be through submission of Form JC-1 (*Joint Check Notification Form*) and the use of joint checks shall be in accordance with the Department's Joint Check Procedures.

#### **(C) Subcontracts (Non-Trucking)**

A MBE/WBE may enter into subcontracts. Work that a MBE subcontracts to another MBE firm may be counted toward the MBE contract goal requirement. The same holds for work that a WBE subcontracts to another WBE firm. Work that a MBE subcontracts to a non-MBE firm does not count toward the MBE contract goal requirement. Again, the same holds true for the work that a WBE subcontracts to a non-WBE firm. If a MBE or WBE contractor or subcontractor subcontracts a significantly greater portion of the work of the contract than would be expected on the basis of standard industry practices, it shall be presumed that the MBE or WBE is not performing a commercially useful function. The MBE/WBE may present evidence to rebut this presumption to the Department. The Department's decision on the rebuttal of this presumption may be subject to review by the Office of Inspector General, NCDOT.

#### **(D) Joint Venture**

When a MBE or WBE performs as a participant in a joint venture, the Contractor may count toward its contract goal requirement a portion of the total value of participation with the MBE or WBE in the joint venture, that portion of the total dollar value being a distinct clearly defined portion of work that the MBE or WBE performs with its forces.

(E) Suppliers

A contractor may count toward its MBE or WBE requirement 60 percent of its expenditures for materials and supplies required to complete the contract and obtained from a MBE or WBE regular dealer and 100 percent of such expenditures from a MBE or WBE manufacturer.

(F) Manufacturers and Regular Dealers

A contractor may count toward its MBE or WBE requirement the following expenditures to MBE/WBE firms that are not manufacturers or regular dealers:

- (1) The fees or commissions charged by a MBE/WBE firm for providing a *bona fide* service, such as professional, technical, consultant, or managerial services, or for providing bonds or insurance specifically required for the performance of a DOT-assisted contract, provided the fees or commissions are determined to be reasonable and not excessive as compared with fees and commissions customarily allowed for similar services.
- (2) With respect to materials or supplies purchased from a MBE/WBE, which is neither a manufacturer nor a regular dealer, count the entire amount of fees or commissions charged for assistance in the procurement of the materials and supplies, or fees or transportation charges for the delivery of materials or supplies required on a job site (but not the cost of the materials and supplies themselves), provided the fees are determined to be reasonable and not excessive as compared with fees customarily allowed for similar services.

**Commercially Useful Function**

(A) MBE/WBE Utilization

The Contractor may count toward its contract goal requirement only expenditures to MBEs and WBEs that perform a commercially useful function in the work of a contract. A MBE/WBE performs a commercially useful function when it is responsible for execution of the work of the contract and is carrying out its responsibilities by actually performing, managing, and supervising the work involved. To perform a commercially useful function, the MBE/WBE shall also be responsible with respect to materials and supplies used on the contract, for negotiating price, determining quality and quantity, ordering the material and installing (where applicable) and paying for the material itself. To determine whether a MBE/WBE is performing a commercially useful function, the Department will evaluate the amount of work subcontracted, industry practices, whether the amount the firm is to be paid under the contract is commensurate with the work it is actually performing and the MBE/WBE credit claimed for its performance of the work, and any other relevant factors.

(B) MBE/WBE Utilization in Trucking

The following factors will be used to determine if a MBE or WBE trucking firm is performing a commercially useful function:

- (1) The MBE/WBE shall be responsible for the management and supervision of the entire trucking operation for which it is responsible on a particular contract, and there shall not be a contrived arrangement for the purpose of meeting the MBE or WBE goal.
- (2) The MBE/WBE shall itself own and operate at least one fully licensed, insured, and operational truck used on the contract.
- (3) The MBE/WBE receives credit for the total value of the transportation services it provides on the contract using trucks it owns, insures, and operates using drivers it employs.
- (4) The MBE may subcontract the work to another MBE firm, including an owner-operator who is certified as a MBE. The same holds true that a WBE may subcontract the work to another WBE firm, including an owner-operator who is certified as a WBE. When this occurs, the MBE or WBE who subcontracts work receives credit for the total value of the transportation services the subcontracted MBE or WBE provides on the contract. It should be noted that every effort shall be made by MBE and WBE contractors to subcontract to the same certification (i.e., MBEs to MBEs and WBEs to WBEs), in order to fulfill the goal requirement. This, however, may not always be possible due to the limitation of firms in the area. If the MBE or WBE firm shows a good faith effort has been made to reach out to similarly certified transportation service providers and there is no interest or availability, and they can get assistance from other certified providers, the Engineer will not hold the prime liable for meeting the goal.
- (5) The MBE/WBE may also subcontract the work to a non-MBE/WBE firm, including from an owner-operator. The MBE/WBE who subcontracts the work to a non-MBE/WBE is entitled to credit for the total value of transportation services provided by the non-MBE/WBE subcontractor not to exceed the value of transportation services provided by MBE/WBE-owned trucks on the contract. Additional participation by non-MBE/WBE subcontractors receives credit only for the fee or commission it receives as a result of the subcontract arrangement. The value of services performed under subcontract agreements between the MBE/WBE and the Contractor will not count towards the MBE/WBE contract requirement.
- (6) A MBE/WBE may lease truck(s) from an established equipment leasing business open to the general public. The lease must indicate that the MBE/WBE has exclusive use of and control over the truck. This requirement does not preclude the leased truck from working for others during the term of the lease with the consent of the MBE/WBE, so long as the lease gives the MBE/WBE absolute priority for use of the leased truck. This type of lease may count toward the MBE/WBE's credit as long as the driver is under the MBE/WBE's payroll.
- (7) Subcontracted/leased trucks shall display clearly on the dashboard the name of the MBE/WBE that they are subcontracted/leased to and their own company name if it is not identified on the truck itself. Magnetic door signs are not permitted.



## **MBE/WBE Replacement**

When a Contractor has relied on a commitment to a MBE or WBE firm (or an approved substitute MBE or WBE firm) to meet all or part of a contract goal requirement, the contractor shall not terminate the MBE/WBE for convenience. This includes, but is not limited to, instances in which the Contractor seeks to perform the work of the terminated subcontractor with another MBE/WBE subcontractor, a non-MBE/WBE subcontractor, or with the Contractor's own forces or those of an affiliate. A MBE/WBE may only be terminated after receiving the Engineer's written approval based upon a finding of good cause for the termination.

All requests for replacement of a committed MBE/WBE firm shall be submitted to the Engineer for approval on Form RF-1 (*Replacement Request*). If the Contractor fails to follow this procedure, the Contractor may be disqualified from further bidding for a period of up to 6 months.

The Contractor shall comply with the following for replacement of a committed MBE/WBE:

### **(A) Performance Related Replacement**

When a committed MBE is terminated for good cause as stated above, an additional MBE that was submitted at the time of bid may be used to fulfill the MBE commitment. The same holds true if a committed WBE is terminated for good cause, an additional WBE that was submitted at the time of bid may be used to fulfill the WBE goal. A good faith effort will only be required for removing a committed MBE/WBE if there were no additional MBEs/WBEs submitted at the time of bid to cover the same amount of work as the MBE/WBE that was terminated.

If a replacement MBE/WBE is not found that can perform at least the same amount of work as the terminated MBE/WBE, the Contractor shall submit a good faith effort documenting the steps taken. Such documentation shall include, but not be limited to, the following:

- (1) Copies of written notification to MBEs/WBEs that their interest is solicited in contracting the work defaulted by the previous MBE/WBE or in subcontracting other items of work in the contract.
- (2) Efforts to negotiate with MBEs/WBEs for specific subbids including, at a minimum:
  - (a) The names, addresses, and telephone numbers of MBEs/WBEs who were contacted.
  - (b) A description of the information provided to MBEs/WBEs regarding the plans and specifications for portions of the work to be performed.
- (3) A list of reasons why MBE/WBE quotes were not accepted.
- (4) Efforts made to assist the MBEs/WBEs contacted, if needed, in obtaining bonding or insurance required by the Contractor.

### **(B) Decertification Replacement**

- (1) When a committed MBE/WBE is decertified by the Department after the SAF (*Subcontract Approval Form*) has been received by the Department, the Department will not require the Contractor to solicit replacement MBE/WBE participation equal to

the remaining work to be performed by the decertified firm. The participation equal to the remaining work performed by the decertified firm will count toward the contract goal requirement.

- (2) When a committed MBE/WBE is decertified prior to the Department receiving the SAF (*Subcontract Approval Form*) for the named MBE/WBE firm, the Contractor shall take all necessary and reasonable steps to replace the MBE/WBE subcontractor with another similarly certified MBE/WBE subcontractor to perform at least the same amount of work to meet the MBE/WBE goal requirement. If a MBE/WBE firm is not found to do the same amount of work, a good faith effort must be submitted to NCDOT (see A herein for required documentation).

### **Changes in the Work**

When the Engineer makes changes that result in the reduction or elimination of work to be performed by a committed MBE/WBE, the Contractor will not be required to seek additional participation. When the Engineer makes changes that result in additional work to be performed by a MBE/WBE based upon the Contractor's commitment, the MBE/WBE shall participate in additional work to the same extent as the MBE/WBE participated in the original contract work.

When the Engineer makes changes that result in extra work, which has more than a minimal impact on the contract amount, the Contractor shall seek additional participation by MBEs/WBEs unless otherwise approved by the Engineer.

When the Engineer makes changes that result in an alteration of plans or details of construction, and a portion or all of the work had been expected to be performed by a committed MBE/WBE, the Contractor shall seek participation by MBEs/WBEs unless otherwise approved by the Engineer.

When the Contractor requests changes in the work that result in the reduction or elimination of work that the Contractor committed to be performed by a MBE/WBE, the Contractor shall seek additional participation by MBEs/WBEs equal to the reduced MBE/WBE participation caused by the changes.

### **Reports and Documentation**

A SAF (*Subcontract Approval Form*) shall be submitted for all work which is to be performed by a MBE/WBE subcontractor. The Department reserves the right to require copies of actual subcontract agreements involving MBE/WBE subcontractors.

When using transportation services to meet the contract commitment, the Contractor shall submit a proposed trucking plan in addition to the SAF. The plan shall be submitted prior to beginning construction on the project. The plan shall include the names of all trucking firms proposed for use, their certification type(s), the number of trucks owned by the firm, as well as the individual truck identification numbers, and the line item(s) being performed.

Within 30 calendar days of entering into an agreement with a MBE/WBE for materials, supplies or services, not otherwise documented by the SAF as specified above, the Contractor shall furnish the Engineer a copy of the agreement. The documentation shall also indicate the percentage (60% or 100%) of expenditures claimed for MBE/WBE credit.

## **Reporting Minority and Women Business Enterprise Participation**

The Contractor shall provide the Engineer with an accounting of payments made to all MBE and WBE firms, including material suppliers and contractors at all levels (prime, subcontractor, or second tier subcontractor). This accounting shall be furnished to the Engineer for any given month by the end of the following month. Failure to submit this information accordingly may result in the following action:

- (A) Withholding of money due in the next partial pay estimate; or
- (B) Removal of an approved contractor from the prequalified bidders' list or the removal of other entities from the approved subcontractors list.

While each contractor (prime, subcontractor, 2nd tier subcontractor) is responsible for accurate accounting of payments to MBEs/WBEs, it shall be the prime contractor's responsibility to report all monthly and final payment information in the correct reporting manner.

Failure on the part of the Contractor to submit the required information in the time frame specified may result in the disqualification of that contractor and any affiliate companies from further bidding until the required information is submitted.

Failure on the part of any subcontractor to submit the required information in the time frame specified may result in the disqualification of that contractor and any affiliate companies from being approved for further work on future projects until the required information is submitted.

Contractors reporting transportation services provided by non-MBE/WBE lessees shall evaluate the value of services provided during the month of the reporting period only.

At any time, the Engineer can request written verification of subcontractor payments.

The Contractor shall report the accounting of payments on the Department's DBE-IS (*Subcontractor Payment Information*) with each invoice. Invoices will not be processed for payment until the DBE-IS is received.

## **Failure to Meet Contract Requirements**

Failure to meet contract requirements in accordance with Subarticle 102-15(J) of the *2012 Standard Specifications* may be cause to disqualify the Contractor.

## **SUBSURFACE INFORMATION:**

(7-1-95)

450

SP1 G112 C

There is **no** subsurface information available on this project. The Contractor shall make his own investigation of subsurface conditions.

**LOCATING EXISTING UNDERGROUND UTILITIES:**

(3-20-12)

105

SP1 G115

Revise the *2012 Standard Specifications* as follows:

**Page 1-43, Article 105-8, line 28, after the first sentence,** add the following:

Identify excavation locations by means of pre-marking with white paint, flags, or stakes or provide a specific written description of the location in the locate request.

**MAINTENANCE OF THE PROJECT:**

(11-20-07) (Rev. 1-17-12)

104-10

SP1 G125

Revise the *2012 Standard Specifications* as follows:

**Page 1-35, Article 104-10 Maintenance of the Project, line 25,** add the following after the first sentence of the first paragraph:

All guardrail/guiderail within the project limits shall be included in this maintenance.

**Page 1-35, Article 104-10 Maintenance of the Project, line 30,** add the following as the last sentence of the first paragraph:

The Contractor shall perform weekly inspections of guardrail and guiderail and shall report damages to the Engineer on the same day of the weekly inspection. *Where damaged guardrail or guiderail is repaired or replaced as a result of maintaining the project in accordance with this article,* such repair or replacement shall be performed within 7 consecutive calendar days of such inspection report.

**Page 1-35, Article 104-10 Maintenance of the Project, lines 42-44,** replace the last sentence of the last paragraph with the following:

The Contractor will not be directly compensated for any maintenance operations necessary, except for maintenance of guardrail/guiderail, as this work will be considered incidental to the work covered by the various contract items. The provisions of Article 104-7, Extra Work, and Article 104-8, Compensation and Record Keeping will apply to authorized maintenance of guardrail/guiderail. Performance of weekly inspections of guardrail/guiderail, and the damage reports required as described above, will be considered to be an incidental part of the work being paid for by the various contract items.

**COOPERATION BETWEEN CONTRACTORS:**

(7-1-95)

105-7

SP1 G133

The Contractor's attention is directed to Article 105-7 of the *2012 Standard Specifications*.

The Contractor on this project shall cooperate with the Contractor working within or adjacent to the limits of this project to the extent that the work can be carried out to the best advantage of all concerned.

**GIFTS FROM VENDORS AND CONTRACTORS:**

(12-15-09)

107-1

SP1 G152

By Executive Order 24, issued by Governor Perdue, and *N.C.G.S. § 133-32*, it is unlawful for any vendor or contractor (i.e. architect, bidder, contractor, construction manager, design professional, engineer, landlord, offer or, seller, subcontractor, supplier, or vendor), to make gifts or to give favors to any State employee of the Governor's Cabinet Agencies (i.e. Administration, Commerce, Correction, Crime

Control and Public Safety, Cultural Resources, Environment and Natural Resources, Health and Human Services, Juvenile Justice and Delinquency Prevention, Revenue, Transportation, and the Office of the Governor). This prohibition covers those vendors and contractors who:

- (A) Have a contract with a governmental agency; or
- (B) Have performed under such a contract within the past year; or
- (C) Anticipate bidding on such a contract in the future.

For additional information regarding the specific requirements and exemptions, vendors and contractors are encouraged to review Executive Order 24 and *N.C.G.S. § 133-32*.

Executive Order 24 also encouraged and invited other State Agencies to implement the requirements and prohibitions of the Executive Order to their agencies. Vendors and contractors should contact other State Agencies to determine if those agencies have adopted Executive Order 24.

**EROSION AND SEDIMENT CONTROL/STORMWATER CERTIFICATION:**

(1-16-07) (Rev 11-16-10)

105-16, 225-2, 16

SP1 G180

**General**

Schedule and conduct construction activities in a manner that will minimize soil erosion and the resulting sedimentation and turbidity of surface waters. Comply with the requirements herein regardless of whether or not a National Pollution discharge Elimination System (NPDES) permit for the work is required.

Establish a chain of responsibility for operations and subcontractors' operations to ensure that the *Erosion and Sediment Control/Stormwater Pollution Prevention Plan* is implemented and maintained over the life of the contract.

- (A) *Certified Supervisor* - Provide a certified Erosion and Sediment Control/Stormwater Supervisor to manage the Contractor and subcontractor operations, insure compliance with Federal, State and Local ordinances and regulations, and manage the Quality Control Program.
- (B) *Certified Foreman* - Provide a certified, trained foreman for each construction operation that increases the potential for soil erosion or the possible sedimentation and turbidity of surface waters.
- (C) *Certified Installer* - Provide a certified installer to install or direct the installation for erosion or sediment/stormwater control practices.
- (D) *Certified Designer* - Provide a certified designer for the design of the erosion and sediment control/stormwater component of reclamation plans and, if applicable, for the design of the project erosion and sediment control/stormwater plan.

**Roles and Responsibilities**

- (A) *Certified Erosion and Sediment Control/Stormwater Supervisor* - The Certified Supervisor shall be Level II and responsible for ensuring the erosion and sediment control/stormwater plan is adequately implemented and maintained on the project and for conducting the quality control program. The Certified Supervisor shall be on the project within 24 hours notice from initial exposure of an erodible surface to the project's final acceptance. Perform the following duties:

- (1) Manage Operations - Coordinate and schedule the work of subcontractors so that erosion and sediment control/stormwater measures are fully executed for each operation and in a timely manner over the duration of the contract.
  - (a) Oversee the work of subcontractors so that appropriate erosion and sediment control/stormwater preventive measures are conformed to at each stage of the work.
  - (b) Prepare the required National Pollutant Discharge Elimination System (NPDES) Inspection Record and submit to the Engineer.
  - (c) Attend all weekly or monthly construction meetings to discuss the findings of the NPDES inspection and other related issues.
  - (d) Implement the erosion and sediment control/stormwater site plans requested.
  - (e) Provide any needed erosion and sediment control/stormwater practices for the Contractor's temporary work not shown on the plans, such as, but not limited to work platforms, temporary construction, pumping operations, plant and storage yards, and cofferdams.
  - (f) Acquire applicable permits and comply with requirements for borrow pits, dewatering, and any temporary work conducted by the Contractor in jurisdictional areas.
  - (g) Conduct all erosion and sediment control/stormwater work in a timely and workmanlike manner.
  - (h) Fully perform and install erosion and sediment control/stormwater work prior to any suspension of the work.
  - (i) Coordinate with Department, Federal, State and Local Regulatory agencies on resolution of erosion and sediment control/stormwater issues due to the Contractor's operations.
  - (j) Ensure that proper cleanup occurs from vehicle tracking on paved surfaces or any location where sediment leaves the Right-of-Way.
  - (k) Have available a set of erosion and sediment control/stormwater plans that are initialed and include the installation date of Best Management Practices. These practices shall include temporary and permanent groundcover and be properly updated to reflect necessary plan and field changes for use and review by Department personnel as well as regulatory agencies.
  
- (2) Requirements set forth under the NPDES Permit - The Department's NPDES Stormwater permit (NCS000250) outlines certain objectives and management measures pertaining to construction activities. The permit references *NCG010000, General Permit to Discharge Stormwater* under the NPDES, and states that the Department shall incorporate the applicable requirements into its delegated Erosion and Sediment Control Program for construction activities disturbing one or more acres of land. The Department further incorporates these requirements on all contracted bridge and culvert work at jurisdictional waters, regardless of size. Some of the requirements are, but are not limited to:
  - (a) Control project site waste to prevent contamination of surface or ground waters of the state, i.e. from equipment operation/maintenance, construction materials, concrete washout, chemicals, litter, fuels, lubricants, coolants, hydraulic fluids, any other petroleum products, and sanitary waste.
  - (b) Inspect erosion and sediment control/stormwater devices and stormwater discharge outfalls at least once every 7 calendar days, twice weekly for

construction related *Federal Clean Water Act, Section 303(d)* impaired streams with turbidity violations, and within 24 hours after a significant rainfall event of 0.5 inch that occurs within a 24 hour period.

- (c) Maintain an onsite rain gauge or use the Department's Multi-Sensor Precipitation Estimate website to maintain a daily record of rainfall amounts and dates.
  - (d) Maintain erosion and sediment control/stormwater inspection records for review by Department and Regulatory personnel upon request.
  - (e) Implement approved reclamation plans on all borrow pits, waste sites and staging areas.
  - (f) Maintain a log of turbidity test results as outlined in the Department's Procedure for Monitoring Borrow Pit Discharge.
  - (g) Provide secondary containment for bulk storage of liquid materials.
  - (h) Provide training for employees concerning general erosion and sediment control/stormwater awareness, the Department's NPDES Stormwater Permit NCS000250 requirements, and the applicable requirements of the *General Permit, NCG010000*.
  - (i) Report violations of the NPDES permit to the Engineer immediately who will notify the Division of Water Quality Regional Office within 24 hours of becoming aware of the violation.
- (3) Quality Control Program - Maintain a quality control program to control erosion, prevent sedimentation and follow provisions/conditions of permits. The quality control program shall:
- (a) Follow permit requirements related to the Contractor and subcontractors' construction activities.
  - (b) Ensure that all operators and subcontractors on site have the proper erosion and sediment control/stormwater certification.
  - (c) Notify the Engineer when the required certified erosion and sediment control/stormwater personnel are not available on the job site when needed.
  - (d) Conduct the inspections required by the NPDES permit.
  - (e) Take corrective actions in the proper timeframe as required by the NPDES permit for problem areas identified during the NPDES inspections.
  - (f) Incorporate erosion control into the work in a timely manner and stabilize disturbed areas with mulch/seed or vegetative cover on a section-by-section basis.
  - (g) Use flocculants approved by state regulatory authorities where appropriate and where required for turbidity and sedimentation reduction.
  - (h) Ensure proper installation and maintenance of temporary erosion and sediment control devices.
  - (i) Remove temporary erosion or sediment control devices when they are no longer necessary as agreed upon by the Engineer.
  - (j) The Contractor's quality control and inspection procedures shall be subject to review by the Engineer. Maintain NPDES inspection records and make records available at all times for verification by the Engineer.
- (B) *Certified Foreman* - At least one Certified Foreman shall be onsite for each type of work listed herein during the respective construction activities to control erosion, prevent sedimentation and follow permit provisions:
- (1) Foreman in charge of grading activities

- (2) Foreman in charge of bridge or culvert construction over jurisdictional areas
- (3) Foreman in charge of utility activities

The Contractor may request to use the same person as the Level II Supervisor and Level II Foreman. This person shall be onsite whenever construction activities as described above are taking place. This request shall be approved by the Engineer prior to work beginning.

The Contractor may request to name a single Level II Foreman to oversee multiple construction activities on small bridge or culvert replacement projects. This request shall be approved by the Engineer prior to work beginning.

- (C) *Certified Installers* - Provide at least one onsite, Level I Certified Installer for each of the following erosion and sediment control/stormwater crew:

- (1) Seeding and Mulching
- (2) Temporary Seeding
- (3) Temporary Mulching
- (4) Sodding
- (5) Silt fence or other perimeter erosion/sediment control device installations
- (6) Erosion control blanket installation
- (7) Hydraulic tackifier installation
- (8) Turbidity curtain installation
- (9) Rock ditch check/sediment dam installation
- (10) Ditch liner/matting installation
- (11) Inlet protection
- (12) Riprap placement
- (13) Stormwater BMP installations (such as but not limited to level spreaders, retention/detention devices)
- (14) Pipe installations within jurisdictional areas

If a Level I *Certified Installer* is not onsite, the Contractor may substitute a Level II Foreman for a Level I Installer, provided the Level II Foreman is not tasked to another crew requiring Level II Foreman oversight.

- (D) *Certified Designer* - Include the certification number of the Level III-B Certified Designer on the erosion and sediment control/stormwater component of all reclamation plans and if applicable, the certification number of the Level III-A Certified Designer on the design of the project erosion and sediment control/stormwater plan.

### **Preconstruction Meeting**

Furnish the names of the *Certified Erosion and Sediment Control/Stormwater Supervisor*, *Certified Foremen*, *Certified Installers* and *Certified Designer* and notify the Engineer of changes in certified personnel over the life of the contract within 2 days of change.

### **Ethical Responsibility**

Any company performing work for the North Carolina Department of Transportation has the ethical responsibility to fully disclose any reprimand or dismissal of an employee resulting from improper testing or falsification of records.



## **Revocation or Suspension of Certification**

Upon recommendation of the Chief Engineer - Operations to the certification entity, certification for *Supervisor, Certified Foremen, Certified Installers* and *Certified Designer* may be revoked or suspended with the issuance of an *Immediate Corrective Action (ICA)*, *Notice of Violation (NOV)*, or *Cease and Desist Order* for erosion and sediment control/stormwater related issues.

The Chief Engineer may recommend suspension or permanent revocation of certification due to the following:

- (A) Failure to adequately perform the duties as defined within this certification provision.
- (B) Issuance of an ICA, NOV, or Cease and Desist Order.
- (C) Failure to fully perform environmental commitments as detailed within the permit conditions and specifications.
- (D) Demonstration of erroneous documentation or reporting techniques.
- (E) Cheating or copying another candidate's work on an examination.
- (F) Intentional falsification of records.
- (G) Directing a subordinate under direct or indirect supervision to perform any of the above actions.
- (H) Dismissal from a company for any of the above reasons.
- (I) Suspension or revocation of one's certification by another entity.

Suspension or revocation of a certification will be sent by certified mail to the certificant and the Corporate Head of the company that employs the certificant.

A certificant has the right to appeal any adverse action which results in suspension or permanent revocation of certification by responding, in writing, to the Chief Engineer within 10 calendar days after receiving notice of the proposed adverse action.

Chief Engineer - Operations  
1537 Mail Service Center  
Raleigh, NC 27699-1537

Failure to appeal within 10 calendar days will result in the proposed adverse action becoming effective on the date specified on the certified notice. Failure to appeal within the time specified will result in a waiver of all future appeal rights regarding the adverse action taken. The certificant will not be allowed to perform duties associated with the certification during the appeal process.

The Chief Engineer will hear the appeal and make a decision within 7 days of hearing the appeal. Decision of the Chief Engineer will be final and will be made in writing to the certificant.

If a certification is temporarily suspended, the certificant shall pass any applicable written examination and any proficiency examination, at the conclusion of the specified suspension period, prior to having the certification reinstated.

## **Measurement and Payment**

*Certified Erosion and Sediment Control/Stormwater Supervisor, Certified Foremen, Certified Installers* and *Certified Designer* will be incidental to the project for which no direct compensation will be made.

### **PERMANENT VEGETATION ESTABLISHMENT:**

Establish a permanent stand of the vegetation mixture shown in the contract. During the period between initial vegetation planting and final project acceptance, perform all work necessary to establish 80% coverage of permanent vegetation within the project limits, as well as, in borrow and waste pits. This work shall include erosion control device maintenance and installation, repair seeding and mulching, supplemental seeding and mulching, mowing, and fertilizer topdressing, as directed. All work shall be performed in accordance with the applicable section of the *2012 Standard Specifications*.

Once the Engineer has determined that 80% coverage of permanent vegetation has been established, the Contractor will be notified to remove the remaining erosion control devices that are no longer needed. The Contractor will be responsible for, and shall correct any areas disturbed by operations performed in permanent vegetation establishment and the removal of temporary erosion control measures, whether occurring prior to or after placing traffic on the project.

No additional compensation will be made for maintenance and removal of temporary erosion control items.

### **PROCEDURE FOR MONITORING BORROW PIT DISCHARGE:**

(2-20-07)

105-16, 230, 801

SP1 G181

Water discharge from borrow pit sites shall not cause surface waters to exceed 50 NTUs (nephelometric turbidity unit) in streams not designated as trout waters and 10 NTUs in streams, lakes or reservoirs designated as trout waters. For lakes and reservoirs not designated as trout waters, the turbidity shall not exceed 25 NTUs. If the turbidity exceeds these levels due to natural background conditions, the existing turbidity level shall not be increased.

If during any operating day, the downstream water quality exceeds the standard, the Contractor shall do all of the following:

- (A) Either cease discharge or modify the discharge volume or turbidity levels to bring the downstream turbidity levels into compliance, or
- (B) Evaluate the upstream conditions to determine if the exceedance of the standard is due to natural background conditions. If the background turbidity measurements exceed the standard, operation of the pit and discharge can continue as long as the stream turbidity levels are not increased due to the discharge.
- (C) Measure and record the turbidity test results (time, date and sampler) at all defined sampling locations 30 minutes after startup and at a minimum, one additional sampling of all sampling locations during that 24-hour period in which the borrow pit is discharging.
- (D) Notify DWQ within 24 hours of any stream turbidity standard exceedances that are not brought into compliance.

During the Environmental Assessment required by Article 230-4 of the *2012 Standard Specifications*, the Contractor shall define the point at which the discharge enters into the State's surface waters and the appropriate sampling locations. Sampling locations shall include points upstream and downstream from the point at which the discharge enters these waters. Upstream sampling location shall be located so that it is not influenced by backwater conditions and represents natural background conditions. Downstream

sampling location shall be located at the point where complete mixing of the discharge and receiving water has occurred.

The discharge shall be closely monitored when water from the dewatering activities is introduced into jurisdictional wetlands. Any time visible sedimentation (deposition of sediment) on the wetland surface is observed, the dewatering activity will be suspended until turbidity levels in the stilling basin can be reduced to a level where sediment deposition does not occur. Staining of wetland surfaces from suspended clay particles, occurring after evaporation or infiltration, does not constitute sedimentation. No activities shall occur in wetlands that adversely affect the functioning of a wetland. Visible sedimentation will be considered an indication of possible adverse impacts on wetland use.

The Engineer will perform independent turbidity tests on a random basis. These results will be maintained in a log within the project records. Records will include, at a minimum, turbidity test results, time, date and name of sampler. Should the Department's test results exceed those of the Contractor's test results, an immediate test shall be performed jointly with the results superseding the previous test results of both the Department and the Contractor.

The Contractor shall use the *NCDOT Turbidity Reduction Options for Borrow Pits Matrix*, available at <http://www.ncdot.org/doh/preconstruct/ps/contracts/letting.html> to plan, design, construct, and maintain BMPs to address water quality standards. Tier I Methods include stilling basins which are standard compensatory BMPs. Other Tier I methods are noncompensatory and shall be used when needed to meet the stream turbidity standards. Tier II Methods are also noncompensatory and are options that may be needed for protection of rare or unique resources or where special environmental conditions exist at the site which have led to additional requirements being placed in the DWQ's 401 Certifications and approval letters, Isolated Wetland Permits, Riparian Buffer Authorization or a DOT Reclamation Plan's Environmental Assessment for the specific site. Should the Contractor exhaust all Tier I Methods on a site exclusive of rare or unique resources or special environmental conditions, Tier II Methods may be required by regulators on a case by case basis per supplemental agreement.

The Contractor may use cation exchange capacity (CEC) values from proposed site borings to plan and develop the bid for the project. CEC values exceeding 15 milliequivalents per 100 grams of soil may indicate a high potential for turbidity and should be avoided when dewatering into surface water is proposed.

No additional compensation for monitoring borrow pit discharge will be paid.

**EMPLOYMENT:**

(11-15-11) (Rev. 1-17-12)

108, 102

SP1 G184

Revise the *2012 Standard Specifications* as follows:

**Page 1-20, Subarticle 102-15(O)**, delete and replace with the following:

**(O)** Failure to restrict a former Department employee as prohibited by Article 108-5.

**Page 1-65, Article 108-5 Character of Workmen, Methods, and Equipment, line 32**, delete all of line 32, the first sentence of the second paragraph and the first word of the second sentence of the second paragraph.

**DAMAGE TO EXISTING PAVEMENT, BASE, SUBGRADE AND PROPOSED PAVEMENT:**

In addition to the requirements of the Standard Specifications concerning this subject, the Contractor is cautioned that he will be held responsible for all damages to the pavement, base, and subgrade caused by his operations, including but not limited to, rutting and shoving of the existing or proposed pavement and yielding or rutting of the existing base and subgrade.

The Contractor is cautioned to limit the weight of his equipment and the frequency of hauls so as to not damage the existing pavement, base, subgrade and the proposed pavement.

Any subgrade or base failures which the Contractor finds prior to the beginning of his operations or during the conditioning of the existing base are to be brought to the attention of the Engineer in writing. Repairs to those areas will be made by DOT forces. Once these deficient areas have been repaired, the requirements of this Special Provision will fully apply.

**DRIVEWAYS AND PRIVATE PROPERTY:**

The Contractor shall maintain access to driveways for all residents and property owners throughout the life of the project.

The Contractor shall not perform work for private citizens or agencies in conjunction with this project or within the project limits of this contract.

**LITTER PICK-UP:**

Litter pick-up shall be performed on all areas. Litter pick-up consisting of construction debris, will be considered incidental to mobilization. No additional compensation will be made for litter pick-up.

**NOTIFICATION OF OPERATIONS:**

The Contractor shall notify the Engineer three weeks in advance of beginning work on this project. The Contractor shall give the Engineer sufficient notice of all operations for any sampling, inspection or acceptance testing required.

**PLAN, DETAIL AND QUANTITY ADJUSTMENTS:**

The Department reserves the right to make, at any time during the progress of the work, such alterations in plans or the details of construction as may be found necessary or desirable by the Engineer to complete the project.

**PRECONSTRUCTION CONFERENCE:**

In accordance with Section 108-3 of the Standard Specifications, a preconstruction conference will be required prior to beginning work.

**PROSECUTION AND PROGRESS:**

The Contractor shall prepare and submit to the Engineer a proposed schedule of operations prior to beginning work on this project. The schedule should indicate the proposed chronological sequence of operations and may be revised within the limits of the contract with the approval of the Engineer.

No work may be performed on legal State holidays. Work shall only be performed when weather and visibility conditions allow safe operations. The Contractor's vehicles and equipment shall not be parked

within the State Highway System right of way overnight or at other times when work has been suspended unless approved by the Engineer. The Engineer may designate specific locations for parking equipment.

The Contractor shall temporarily remove his equipment from the travelway for emergency vehicles and school buses as directed by the Engineer.

**UTILITY COORDINATION:**

It shall be the responsibility of the Contractor to contact all affected utility owners and determine the precise locations of all utilities prior to beginning construction. Utility owners shall be contacted a minimum of 72 hours prior to the commencement of operations. Special care shall be used in working around or near existing utilities, protecting them when necessary to provide uninterrupted service. In the event that any utility service is interrupted, the Contractor shall notify the utility owner immediately and shall cooperate with the owner, or his representative, in the restoration of service in the shortest time possible. Existing fire hydrants shall be kept accessible to fire departments at all times.

The Contractor shall make a reasonable effort to prevent utility relocations. The Engineer shall be notified for approval prior to any utility relocation. The Contractor shall be responsible for all other utility coordination.

**Utility coordination will be incidental to the project for which no direct compensation will be made.**

**NOTES TO CONTRACTOR:**

The Contractors attention is directed to the following:

1. The successful bidder, within fourteen (14) days after notice of award, shall provide the Department with the certificate of Liability insurance.
2. The Department will install and maintain all road closures and detours for this project. The contractor will be responsible for maintaining the Type III Barricades adjacent to the construction site.
3. The Contractor will be responsible for any lane closures needed once the road has been opened to traffic. Payment for lane closures and the traffic control devices used will be incidental to the project for which no direct compensation will be made.

**SHOULDER AND FILL SLOPE MATERIAL:**

(5-21-02)

235, 560

SP2 R45 A

**Description**

Perform the required shoulder and slope construction for this project in accordance with the applicable requirements of Section 560 and Section 235 of the *2012 Standard Specifications*.

**Measurement and Payment**

Where the material has been obtained from an authorized stockpile or from a borrow source and *Borrow Excavation* is not included in the contract, no direct payment will be made for this work, as the cost of this work will be part of the work being paid at the contract lump sum price for *Grading*. If *Borrow Excavation* is included in this contract and the material has been obtained from an authorized stockpile or from a borrow source, measurement and payment will be as provided in Section 230 of the *2012 Standard Specifications* for *Borrow Excavation*.

**ASPHALT PAVEMENTS - SUPERPAVE:**

(6-19-12)

605

SP6 R01

Revise the *2012 Standard Specifications* as follows:

**Page 6-3, Article 605-7 APPLICATION RATES AND TEMPERATURES**, replace this article, including Table 601-1, with the following:

Apply tack coat uniformly across the existing surface at target application rates shown in Table 605-1.

<b>TABLE 605-1 APPLICATION RATES FOR TACK COAT</b>	
<b>Existing Surface</b>	<b>Target Rate (gal/sy)</b>
	<b>Emulsified Asphalt</b>
New Asphalt	0.04 ± 0.01
Oxidized or Milled Asphalt	0.06 ± 0.01
Concrete	0.08 ± 0.01

Apply tack coat at a temperature within the ranges shown in Table 605-2. Tack coat shall not be overheated during storage, transport or at application.

<b>TABLE 605-2</b>	
<b>APPLICATION TEMPERATURE FOR TACK COAT</b>	
<b>Asphalt Material</b>	<b>Temperature Range</b>
Asphalt Binder, Grade PG 64-22	350 - 400°F
Emulsified Asphalt, Grade RS-1H	130 - 160°F
Emulsified Asphalt, Grade CRS-1	130 - 160°F
Emulsified Asphalt, Grade CRS-1H	130 - 160°F
Emulsified Asphalt, Grade HFMS-1	130 - 160°F
Emulsified Asphalt, Grade CRS-2	130 - 160°F

**Page 6-18, Article 610-1 DESCRIPTION**, lines 40-41, delete the last sentence of the last paragraph.

**Page 6-19, Subarticle 610-3(A) Mix Design-General**, line 5, add the following as the first paragraph:

Warm mix asphalt (WMA) is allowed for use at the Contractor’s option in accordance with the NCDOT Approved Products List for WMA Technologies available at:  
<http://www.ncdot.org/doh/operations/materials/pdf/wma.pdf>.

**ASPHALT BINDER CONTENT OF ASPHALT PLANT MIXES:**

(11-21-00) (Rev. 7-17-12)

609

SP6 R15

The approximate asphalt binder content of the asphalt concrete plant mixtures used on this project will be as follows:

Asphalt Concrete Base Course	Type B 25.0__	4.4%
Asphalt Concrete Surface Course	Type SF 9.5A	6.7%

The actual asphalt binder content will be established during construction by the Engineer within the limits established in the *2012 Standard Specifications*.

**ASPHALT PLANT MIXTURES:**

(7-1-95)

609

SP6 R20

Place asphalt concrete base course material in trench sections with asphalt pavement spreaders made for the purpose or with other equipment approved by the Engineer.

**ASPHALT PATCHING**

The open cut shall require full depth patching with three (3) inches of Asphalt Concrete Intermediate Course, Type I19.0B, and an overlay of one and one-half (1.5) inches of Asphalt Concrete Surface Course, Type SF9.5A. The surface course shall extend one-hundred (100) feet beyond the open cut on both sides for an approximate length of two-hundred fifty (250) feet.

Payment will be made under:

<b>Pay Item</b>	<b>Pay Unit</b>
Asphalt Patching Type I 19.0B	Ton
Asphalt Patching Type SF 9.5A	Ton

**FINAL SURFACE TESTING NOT REQUIRED:**

(5-18-04) (Rev. 5-15-12)

610

SP6 R45

Final surface testing is not required on this project.

**MATERIALS:**

(2-21-12) (Rev. 6-19-12)

1005, 1081, 1092

SP10 R01

Revise the 2012 Standard Specifications as follows:

**Page 10-23, Table 1005-1, AGGREGATE GRADATION-COARSE AGGREGATE**, replace with the following:

<b>TABLE 1005-1 AGGREGATE GRADATION - COARSE AGGREGATE</b>													
<b>Percentage of Total by Weight Passing</b>													
<b>Std. Size #</b>	<b>2"</b>	<b>1 1/2"</b>	<b>1"</b>	<b>3/4"</b>	<b>1/2"</b>	<b>3/8"</b>	<b>#4</b>	<b>#8</b>	<b>#10</b>	<b>#16</b>	<b>#40</b>	<b>#200</b>	<b>Remarks</b>
4	100	90-100	20-55	0-15	-	0-5	-	-	-	-	-	A	Asphalt Plant Mix
467M	100	95-100	-	35-70	-	0-30	0-5	-	-	-	-	A	Asphalt Plant Mix
5	-	100	90-100	20-55	0-10	0-5	-	-	-	-	-	A	AST, Sediment Control Stone
57	-	100	95-100	-	25-60	-	0-10	0-5	-	-	-	A	AST, Str. Concrete, Shoulder Drain, Sediment Control Stone
57M	-	100	95-100	-	25-45	-	0-10	0-5	-	-	-	A	AST, Concrete Pavement
6M	-	-	100	90-100	20-55	0-20	0-8	-	-	-	-	A	AST
67	-	-	100	90-100	-	20-55	0-10	0-5	-	-	-	A	AST, Str. Concrete, Asphalt Plant Mix
78M	-	-	-	100	98-100	75-100	20-45	0-15	-	-	-	A	Asphalt Plant Mix, AST, Str. Conc, Weep Hole Drains
14M	-	-	-	-	-	100	35-70	5-20	-	0-8	-	A	Asphalt Plant Mix, AST, Weep Hole Drains, Str. Concrete
9	-	-	-	-	-	100	85-100	10-40	-	0-10	-	A	AST
ABC	-	100	75-97	-	55-80	-	35-55	-	25-45	-	14-30	4-12 <sup>B</sup>	Aggregate Base Course, Aggregate Stabilization
ABC (M)	-	100	75-100	-	45-79	-	20-40	-	0-25	-	-	0-12 <sup>B</sup>	Maintenance Stabilization
Light-weight <sup>C</sup>	-	-	-	-	100	80-100	5-40	0-20	-	0-10	-	0-2.5	AST

- A. See Subarticle 1005-4(A).
- B. See Subarticle 1005-4(B).
- C. For Lightweight Aggregate used in Structural Concrete, see Subarticle 1014-2(E)(6).



**Page 10-162, Subarticle 1081-1(A) Classifications, lines 4-7,** delete the second and third sentences of the description for Type 3A.

**Page 10-162, Subarticle 1081-1(B) Requirements, lines 26-30,** replace the second paragraph with the following:

For epoxy resin systems used for embedding dowel bars, threaded rods, rebar, anchor bolts and other fixtures in hardened concrete, the manufacturer shall submit test results showing that the bonding system will obtain 125% of the specified required yield strength of the fixture. Furnish certification that, for the particular bolt grade, diameter and embedment depth required, the anchor system will not fail by adhesive failure and that there is no movement of the anchor bolt. For certification and anchorage, use 3,000 psi as the minimum Portland cement concrete compressive strength used in this test. Use adhesives that meet Section 1081.

List the properties of the adhesive on the container and include density, minimum and maximum temperature application, setting time, shelf life, pot life, shear strength and compressive strength.

**Page 10-169, Subarticle 1081-3(G) Anchor Bolt Adhesives,** delete this subarticle.

**Page 10-204, Subarticle 1092-2(A) Performance and Test Requirements,** replace **Table 1092-3 Minimum Coefficient of Retroreflection for NC Grade A** with the following:

<b>Observation Angle, degrees</b>	<b>Entrance Angle, degrees</b>	<b>White</b>	<b>Yellow</b>	<b>Green</b>	<b>Red</b>	<b>Blue</b>	<b>Fluorescent Yellow Green</b>	<b>Fluorescent Yellow</b>
0.2	-4.0	525	395	52	95	30	420	315
0.2	30.0	215	162	22	43	10	170	130
0.5	-4.0	310	230	31	56	18	245	185
0.5	30.0	135	100	14	27	6	110	81
1.0	-4.0	<b>120</b>	60	8	16	3.6	64	48
1.0	30.0	45	34	4.5	9	2	36	27

**SELECT MATERIAL, CLASS III, TYPE 3:**

(1-17-12)

1016, 1044

SP10 R05

Revise the 2012 *Standard Specifications* as follows:

**Page 10-39, Article 1016-3, CLASS III,** add the following after line 14:

**Type 3 Select Material**

Type 3 select material is a natural or manufactured fine aggregate material meeting the following gradation requirements and as described in Sections 1005 and 1006:

Percentage of Total by Weight Passing							
3/8"	#4	#8	#16	#30	#50	#100	#200
100	95-100	65-100	35-95	15-75	5-35	0-25	0-8

**Page 10-39, Article 1016-3, CLASS III, line 15**, replace “either type” with “Type 1, Type 2 or Type 3”.

**Page 10-62, Article 1044-1, line 36**, delete the sentence and replace with the following:

Subdrain fine aggregate shall meet Class III select material, Type 1 or Type 3.

**Page 10-63, Article 1044-2, line 2**, delete the sentence and replace with the following:

Subdrain coarse aggregate shall meet Class V select material.

## **COIR FIBER MAT:**

### **Description**

Furnish material, install and maintain coir fiber mat in locations shown on the plans or in locations as directed. Work includes providing all materials, excavating and backfilling, and placing and securing coir fiber mat with stakes, steel reinforcement bars or staples as directed.

### **Materials**

<b>Item</b>	<b>Section</b>
Coir Fiber Mat	1060-14

Anchors: Stakes, reinforcement bars, or staples shall be used as anchors.

#### Wooden Stakes:

Provide hardwood stakes 12"- 24" long with a 2" x 2" nominal square cross section. One end of the stake must be sharpened or beveled to facilitate driving through the coir fiber mat and down into the underlying soil. The other end of the stake needs to have a 1"- 2" long head at the top with a 1"- 2" notch following to catch and secure the coir fiber mat.

#### Steel Reinforcement Bars:

Provide uncoated #10 steel reinforcement bars 24" nominal length. The bars shall have a 4" diameter bend at one end with a 4" straight section at the tip to catch and secure the coir fiber mat.

#### Staples:

Provide staples made of 0.125" diameter new steel wire formed into a *u* shape not less than 12" in length with a throat of 1" in width.

### **Construction Methods**

Place the coir fiber mat immediately upon final grading. Provide a smooth soil surface free from stones, clods, or debris that will prevent the contact of the mat with the soil. Unroll the mat and apply without stretching such that it will lie smoothly but loosely on the soil surface.

For stream relocation applications, take care to preserve the required line, grade, and cross section of the area covered. Bury the top slope end of each piece of mat in a narrow trench at least 6 in. deep and tamp firmly. Where one roll of matting ends and a second roll begins, overlap the end of the upper roll over the buried end of the second roll so there is a 6 in. overlap. Construct check trenches at least 12 in. deep every 50 ft. longitudinally along the edges of the mat or as directed. Fold over and bury mat to the full depth of the trench, close and tamp firmly. Overlap mat at least 6 in. where 2 or more widths of mat are installed side by side.

Place anchors across the mat at the ends approximately 1 ft. apart. Place anchors along the outer edges and down the center of the mat 3 ft. apart.

Adjustments in the trenching or anchoring requirements to fit individual site conditions may be required.

**Measurement and Payment**

*Coir Fiber Mat* will be measured and paid for as the actual number of square yards measured along the surface of the ground over which coir fiber mat is installed and accepted.

No measurement will be made for anchor items.

Payment will be made under:

<b>Pay Item</b>	<b>Pay Unit</b>
Coir Fiber Mat	Square Yard

**WATTLES WITH POLYACRYLAMIDE (PAM):**

(10-19-10) (Rev. 1-17-12)

1060,1630,1631

T2

**Description**

Wattles are tubular products consisting of excelsior fibers encased in synthetic netting. Wattles are used on slopes or channels to intercept runoff and act as a velocity break. Wattles are to be placed at locations shown on the plans or as directed. Installation shall follow the detail provided in the plans and as directed. Work includes furnishing materials, installation of wattles, matting installation, PAM application, and removing wattles.

**Materials**

Wattle shall meet the following specifications:

100% Curled Wood(Excelsior) Fibers	
Minimum Diameter	12 in.
Minimum Density	2.5 lb/ft <sup>3</sup> +/- 10%
Net Material	Synthetic
Net Openings	1 in. x 1 in.
Net Configuration	Totally Encased
Minimum Weight	20 lb. +/- 10% per 10 ft. length

Stakes shall be used as anchors.

Provide hardwood stakes a minimum of 2-ft. long with a 2 in. x 2 in. nominal square cross section. One end of the stake must be sharpened or beveled to facilitate driving down into the underlying soil.

Matting shall meet the requirements of Article 1060-8 of the *2012 Standard Specifications*, or shall meet specifications provided elsewhere in this contract.

Provide staples made of 0.125" diameter new steel wire formed into a *u* shape not less than 12" in length with a throat of 1" in width.

Polyacrylamide (PAM) shall be applied in powder form and shall be anionic or neutrally charged. Soil samples shall be obtained in areas where the wattles will be placed, and from offsite material used to construct the roadway, and analyzed for the appropriate PAM flocculant to be utilized with each wattle. The PAM product used shall be listed on the North Carolina Department of Environment and Natural Resources (NCDENR) Division of Water Quality (DWQ) web site as an approved PAM product for use in North Carolina.

### **Construction Methods**

Wattles shall be secured to the soil by wire staples approximately every 1 linear foot and at the end of each section of wattle. A minimum of 4 stakes shall be installed on the downstream side of the wattle with a maximum spacing of 2 linear feet along the wattle, and according to the detail. Install a minimum of 2 stakes on the upstream side of the wattle according to the detail provided in the plans. Stakes shall be driven into the ground a minimum of 10 in. with no more than 2 in. projecting from the top of the wattle. Drive stakes at an angle according to the detail provided in the plans.

Only install wattle(s) to a height in ditch so flow will not wash around wattle and scour ditch slopes and according to the detail provided in the plans and as directed. Overlap adjoining sections of wattles a minimum of 6 in.

Installation of matting shall be in accordance with the detail provided in the plans, and in accordance with Article 1631-3 of the *2012 Standard Specifications*, or in accordance with specifications provided elsewhere in this contract.

Apply PAM over the lower center portion of the wattle where the water is going to flow over at a rate of 2 ounces per wattle, and 1 ounce of PAM on matting on each side of the wattle. PAM applications shall be done during construction activities after every rainfall event that is equal to or exceeds 0.50 in.

The Contractor shall maintain the wattles until the project is accepted or until the wattles are removed, and shall remove and dispose of silt accumulations at the wattles when so directed in accordance with the requirements of Section 1630 of the *2012 Standard Specifications*.

### **Measurement and Payment**

*Wattles* will be measured and paid for by the actual number of linear feet of wattles which are installed and accepted. Such price and payment will be full compensation for all work covered by this section, including, but not limited to, furnishing all materials, labor, equipment and incidentals necessary to install the *Wattles*.

Matting will be measured and paid for in accordance with Article 1631-4 of the *2012 Standard Specifications*, or in accordance with specifications provided elsewhere in this contract.

*Polyacrylamide (PAM)* will be measured and paid for by the actual weight in pounds of PAM applied to the wattles. Such price and payment will be full compensation for all work covered by this section, including, but not limited to, furnishing all materials, labor, equipment and incidentals necessary to apply the *Polyacrylamide (PAM)*.

Payment will be made under:

<b>Pay Item</b>	<b>Pay Unit</b>
Polyacrylamide (PAM)	Pound
Coir Fiber Wattle	Linear Foot

**PERMITS:**

The Contractor's attention is directed to the following permits, which have been issued to the Department of Transportation by the authority granting the permit.

<b><u>PERMIT</u></b>	<b><u>AUTHORITY GRANTING THE PERMIT</u></b>
Nationwide 3	United States Army Corps of Engineers
WQC 3883	NC Division of Water Quality

The Contractor shall comply with all applicable permit conditions during construction of this project. Those conditions marked by \* are the responsibility of the department and the Contractor has no responsibility in accomplishing those conditions.

Agents of the permitting authority will periodically inspect the project for adherence to the permits.

The Contractor's attention is also directed to Articles 107-10 and 107-13 of the *2012 Standard Specifications* and the following:

Should the Contractor propose to utilize construction methods (such as temporary structures or fill in waters and/or wetlands for haul roads, work platforms, cofferdams, etc.) not specifically identified in the permit (individual, general, or nationwide) authorizing the project it shall be the Contractor's responsibility to coordinate with the Engineer to determine what, if any, additional permit action is required. The Contractor shall also be responsible for initiating the request for the authorization of such construction method by the permitting agency. The request shall be submitted through the Engineer. The Contractor shall not utilize the construction method until it is approved by the permitting agency. The request normally takes approximately 60 days to process; however, no extensions of time or additional compensation will be granted for delays resulting from the Contractor's request for approval of construction methods not specifically identified in the permit.

**Where construction moratoriums are contained in a permit condition which restricts the Contractor's activities to certain times of the year, those moratoriums will apply only to the portions of the work taking place in the waters or wetlands provided that activities outside those areas is done in such a manner as to not affect the waters or wetlands.**

**PIPE REMOVAL**

Remove and dispose of all existing roadway drainage pipe, including flared end sections, where the removal of the existing pipes is required by the plans or as directed. Unless otherwise indicated on the plans, this work does not include the removal and disposal of any existing public or private water or sewage pipe or subsurface and shoulder drain pipe.

Remove existing pipe when so designated on the plans or as directed. When an existing pipe is encountered that is not shown on the plans, do not remove until the Engineer is notified of its presence and has directed its removal. Where traffic is to be maintained, remove pipe in sections so that half the width of the roadway will be available to traffic. Remove existing pipe in such a manner that any nearby facilities will not be damaged. Salvaged pipe is the property of the Contractor unless otherwise indicated by the contract.

Payment will be made under:

<b>Pay Item</b>	<b>Pay Unit</b>
Pipe Removal	Each

**GRADING**

The Contractor is to grade this project to the typical sections and details shown. Grading shall be comprehensive grading as defined in Section 226 of the Standard Specifications, ; and compacting roadway embankment section in conformance with Section 235 of the Standard Specifications, and grading / reshaping of shoulders and ditches.

No earth material may be wasted or removed from the project unless deemed as unsuitable by the Engineer. Material may be stored on the existing roadway provided that adequate clearance is allowed. Waste material deemed unsuitable by the Engineer may be disposed on NCDOT stockpiles upon approval by the local District Engineer. The Contractor shall shape, compact, and grade the embankment, ditches, and shoulders to the lines, grades, and typical sections established by the plans or as directed by the Engineer. The contractor is advised to make a detailed investigation of the original state of such features prior to commencing operations.

The contractor may utilize whatever methods deemed most efficient for the project provided that the work methods comply with all applicable Federal, State, and local laws, ordinances, and regulations governing safety, health, and sanitation and that the contractor will maintain slopes of 2:1 or flatter in the course of excavating the existing embankment. The contractor shall provide all safeguards, safety devices, and protective equipment, and shall take any other needed actions, on his own responsibility that are reasonably necessary to protect property in connection with the performance of the work covered by the contract.

Payment will be made under:

<b>Pay Item</b>	<b>Pay Unit</b>
Grading	Lump Sum

**PIPE AND HEADWALL (INCL. ASSEMBLY AND INSTALLATION)**

Purchasing, assembling and placing the new structure will be the responsibility of the contractor. The manufacturer’s representative, with at least two (2) years of experience in the installation of this type of structure, will be required to be onsite during assembly, placement and backfilling of the structure. The Contractor’s responsibility shall be to excavate the streambed for placement of the toe wall of both

headwalls. When possible pipes will be assembled on the roadbed or other suitable areas, and then placed.

The pipe is required to be buried one foot below the streambed, unless specified otherwise. The Department will provide invert pipe elevations (see "Pipe Information"). The contractor will be responsible for backfilling in accordance with the NCDOT Standard Specifications for Roads and Structures 2012, and as directed by the Engineer. Backfill material shall be #57 stone from two feet below the streambed to one foot above the top and beyond the sides of the pipe. **All #57 stone backfill material shall be encapsulated with engineering fabric. Provide engineering fabric meeting the requirements of Article 1056-2 for any type of engineering fabric. In addition to the engineering fabric the Contractor will be required to place one layer of geogrid (TX170 or equivalent) approximately 6" above and below the structure from headwall to headwall. All engineering fabric and geogrid will be considered incidental to the "Pipe and Headwall (incl. Assembly and Installation)" line item.**

The Contractor shall thoroughly and carefully backfill the pipe in accordance with the pipe assembly plans. Backfilled areas shall be graded and maintained in such a condition that erosion or saturation will not erode or damage the pipe foundation or backfill. Heavy equipment shall not be operated over the pipe until it has been properly backfilled and minimum cover as shown on the plans or as approved by the Engineer has been placed over the pipe.

All material shall be inspected and approved by the Department after delivery to the project and prior to installation.

Payment will be made under:

<b>Pay Item</b>	<b>Pay Unit</b>
Pipe and Headwall (incl. Assembly and Installation)	Each

### **DEWATERING**

All sites shall require dewatering. The preferred method for dewatering will be bypass pumping. Materials used in impervious dikes include but are not limited to steel sheet piles, Aqua Barriers, etc. This will include all material, labor and equipment needed to satisfy the OSHA safety standards and also to satisfy the guidelines of the attached environmental permits. A copy of the environmental permits shall be onsite during construction activities. Any violation of the permits could result in fines. The Contractor's work shall be halted if the turbidity reaches in excess of 50 NTU's. The Contractor shall not resume work until corrections are made.

Included in this contract is a typical section for bypass pumping. The guidelines to be used for this activity can be found in the Best Management Practices for Construction and Maintenance Activities which are available as a down load on our web site. The link can be found @ [http://www.ncdot.org/doh/operations/BMP\\_manual/](http://www.ncdot.org/doh/operations/BMP_manual/).

Payment will be made under:

<b>Pay Item</b>	<b>Pay Unit</b>
Dewatering	Each

### **UTILITY RELOCATIONS**

It shall be the responsibility of the Contractor to contact all affected utility owners and determine the precise locations of all utilities prior to beginning construction. Utility owners shall be contacted within fourteen (14) days after notice of award. Special care shall be used in working around or near existing utilities, protecting them when necessary to provide uninterrupted service. In the event that any utility

service is interrupted, the Contractor shall notify the utility owner immediately and shall cooperate with the owner, or his representative, in the restoration of service in the shortest time possible. Existing fire hydrants shall be kept accessible to fire departments at all times.

Compensation for the "Utility Relocation" Line Item will be based on when the contractor is required to compensate the utility owner for relocation expenses due to existing encroachment agreements. All utility coordination (relocating phone, television, etc.) will be considered incidental to the contract.

The Contractor shall make a reasonable effort to prevent utility relocations. The Engineer shall be notified for approval prior to any utility relocation. The Utility Relocation Line Item will be paid per each utility (water, sewer and gas) relocated at each site; for example, if two (2) water utilities are relocated at one site then two (2) payments will be made on the Utility Relocation Line item.

Payment will be made under:

<b>Pay Item</b>	<b>Pay Unit</b>
Utility Relocations	Each



## **STANDARD SPECIAL PROVISION**

### **AVAILABILITY OF FUNDS – TERMINATION OF CONTRACTS:**

(5-20-08)

Z-2

*General Statute 143C-6-11. (h) Highway Appropriation* is hereby incorporated verbatim in this contract as follows:

(h) Amounts Encumbered. – Transportation project appropriations may be encumbered in the amount of allotments made to the Department of Transportation by the Director for the estimated payments for transportation project contract work to be performed in the appropriation fiscal year. The allotments shall be multiyear allotments and shall be based on estimated revenues and shall be subject to the maximum contract authority contained in *General Statute 143C-6-11(c)*. Payment for transportation project work performed pursuant to contract in any fiscal year other than the current fiscal year is subject to appropriations by the General Assembly. Transportation project contracts shall contain a schedule of estimated completion progress, and any acceleration of this progress shall be subject to the approval of the Department of Transportation provided funds are available. The State reserves the right to terminate or suspend any transportation project contract, and any transportation project contract shall be so terminated or suspended if funds will not be available for payment of the work to be performed during that fiscal year pursuant to the contract. In the event of termination of any contract, the contractor shall be given a written notice of termination at least 60 days before completion of scheduled work for which funds are available. In the event of termination, the contractor shall be paid for the work already performed in accordance with the contract specifications.

Payment will be made on any contract terminated pursuant to the special provision in accordance with Subarticle 108-13(E) of the *2012 Standard Specifications*.

### **NCDOT GENERAL SEED SPECIFICATION FOR SEED QUALITY:**

(5-17-11)

Z-3

Seed shall be sampled and tested by the North Carolina Department of Agriculture and Consumer Services, Seed Testing Laboratory. When said samples are collected, the vendor shall supply an independent laboratory report for each lot to be tested. Results from seed so sampled shall be final. Seed not meeting the specifications shall be rejected by the Department of Transportation and shall not be delivered to North Carolina Department of Transportation warehouses. If seed has been delivered it shall be available for pickup and replacement at the supplier's expense.

Any re-labeling required by the North Carolina Department of Agriculture and Consumer Services, Seed Testing Laboratory, that would cause the label to reflect as otherwise specified herein shall be rejected by the North Carolina Department of Transportation.

Seed shall be free from seeds of the noxious weeds Johnsongrass, Balloonvine, Jimsonweed, Witchweed, Itchgrass, Serrated Tussock, Showy Crotalaria, Smooth Crotalaria, Sicklepod, Sandbur, Wild Onion, and Wild Garlic. Seed shall not be labeled with the above weed species on the seed analysis label. Tolerances as applied by the Association of Official Seed Analysts will NOT be allowed for the above noxious weeds except for Wild Onion and Wild Garlic.

Tolerances established by the Association of Official Seed Analysts will generally be recognized. However, for the purpose of figuring pure live seed, the found pure seed and found germination percentages as reported by the North Carolina Department of Agriculture and Consumer Services, Seed

Testing Laboratory will be used. Allowances, as established by the NCDOT, will be recognized for minimum pure live seed as listed on the following pages.

The specifications for restricted noxious weed seed refers to the number per pound as follows:

<u>Restricted Noxious Weed</u>	<u>Limitations per Lb. Of Seed</u>	<u>Restricted Noxious Weed</u>	<u>Limitations per Lb. of Seed</u>
Blessed Thistle	4 seeds	Cornflower (Ragged Robin)	27 seeds
Cocklebur	4 seeds	Texas Panicum	27 seeds
Spurred Anoda	4 seeds	Bracted Plantain	54 seeds
Velvetleaf	4 seeds	Buckhorn Plantain	54 seeds
Morning-glory	8 seeds	Broadleaf Dock	54 seeds
Corn Cockle	10 seeds	Curly Dock	54 seeds
Wild Radish	12 seeds	Dodder	54 seeds
Purple Nutsedge	27 seeds	Giant Foxtail	54 seeds
Yellow Nutsedge	27 seeds	Horsenettle	54 seeds
Canada Thistle	27 seeds	Quackgrass	54 seeds
Field Bindweed	27 seeds	Wild Mustard	54 seeds
Hedge Bindweed	27 seeds		

Seed of Pensacola Bahiagrass shall not contain more than 7% inert matter, Kentucky Bluegrass, Centipede and Fine or Hard Fescue shall not contain more than 5% inert matter whereas a maximum of 2% inert matter will be allowed on all other kinds of seed. In addition, all seed shall not contain more than 2% other crop seed nor more than 1% total weed seed. The germination rate as tested by the North Carolina Department of Agriculture shall not fall below 70%, which includes both dormant and hard seed. Seed shall be labeled with not more than 7%, 5% or 2% inert matter (according to above specifications), 2% other crop seed and 1% total weed seed.

Exceptions may be made for minimum pure live seed allowances when cases of seed variety shortages are verified. Pure live seed percentages will be applied in a verified shortage situation. Those purchase orders of deficient seed lots will be credited with the percentage that the seed is deficient.

**FURTHER SPECIFICATIONS FOR EACH SEED GROUP ARE GIVEN BELOW:**

Minimum 85% pure live seed; maximum 1% total weed seed; maximum 2% total other crop seed; maximum 144 restricted noxious weed seed per pound. Seed less than 83% pure live seed will not be approved.

    Sericea Lespedeza  
    Oats (seeds)

Minimum 80% pure live seed; maximum 1% total weed seed; maximum 2% total other crop; maximum 144 restricted noxious weed seed per pound. Seed less than 78% pure live seed will not be approved.

Tall Fescue (all approved varieties)	Bermudagrass
Kobe Lespedeza	Browntop Millet
Korean Lespedeza	German Millet – Strain R
Weeping Lovegrass	Clover – Red/White/Crimson
Carpgrass	

Minimum 78% pure live seed; maximum 1% total weed seed; maximum 2% total other crop seed; maximum 144 restricted noxious weed seed per pound. Seed less than 76% pure live seed will not be approved.

Common or Sweet Sundangrass

Minimum 76% pure live seed; maximum 1% total weed seed; maximum 2% total other crop seed; maximum 144 restricted noxious weed seed per pound. Seed less than 74% pure live seed will not be approved.

Rye (grain; all varieties)  
Kentucky Bluegrass (all approved varieties)  
Hard Fescue (all approved varieties)  
Shrub (bicolor) Lespedeza

Minimum 70% pure live seed; maximum 1% total weed seed; maximum 2% total other crop seed; maximum 144 noxious weed seed per pound. Seed less than 70% pure live seed will not be approved.

Centipedegrass	Japanese Millet
Crownvetch	Reed Canary Grass
Pensacola Bahiagrass	Zoysia
Creeping Red Fescue	

Minimum 70% pure live seed; maximum 1% total weed seed; maximum 2% total other crop seed; maximum 5% inert matter; maximum 144 restricted noxious weed seed per pound.

Barnyard Grass  
Big Bluestem  
Little Bluestem  
Bristly Locust  
Birdsfoot Trefoil  
Indiangrass  
Orchardgrass  
Switchgrass  
Yellow Blossom Sweet Clover

**ERRATA**

(1-17-12) (Rev. 9-18-12)

Z-4

Revise the 2012 *Standard Specifications* as follows:

**Division 2**

**Page 2-7, line 31, Article 215-2 Construction Methods,** replace “Article 107-26” with “Article 107-25”.

**Page 2-17, Article 226-3, Measurement and Payment, line 2,** delete “pipe culverts,”.

**Page 2-20, Subarticle 230-4(B), Contractor Furnished Sources, change references as follows: Line 1,** replace “(4) Buffer Zone” with “(c) Buffer Zone”; **Line 12,** replace “(5) Evaluation for Potential Wetlands and Endangered Species” with “(d) Evaluation for Potential Wetlands and Endangered Species”; and **Line 33,** replace “(6) Approval” with “(4) Approval”.

#### **Division 4**

**Page 4-77, line 27, Subarticle 452-3(C) Concrete Coping**, replace “sheet pile” with “reinforcement”.

#### **Division 6**

**Page 6-7, line 31, Article 609-3 Field Verification of Mixture and Job Mix Formula Adjustments**, replace “30” with “45”.

**Page 6-10, line 42, Subarticle 609-6(C)(2)**, replace “Subarticle 609-6(E)” with “Subarticle 609-6(D)”.

**Page 6-11, Table 609-1 Control Limits**, replace “Max. Spec. Limit” for the Target Source of  $P_{0.075}/P_{be}$  Ratio with “1.0”.

**Page 6-40, Article 650-2 Materials**, replace “Subarticle 1012-1(F)” with “Subarticle 1012-1(E)”

#### **Division 10**

**Page 10-74, Table 1056-1 Geotextile Requirements**, replace “50%” for the UV Stability (Retained Strength) of Type 5 geotextiles with “70%”.

#### **Division 12**

**Page 12-7, Table 1205-3**, add “FOR THERMOPLASTIC” to the end of the title.

**Page 12-8, Subarticle 1205-5(B), line 13**, replace “Table 1205-2” with “Table 1205-4”.

**Page 12-8, Table 1205-4 and 1205-5**, replace “THERMOPLASTIC” in the title of these tables with “POLYUREA”.

**Page 12-9, Subarticle 1205-6(B), line 21**, replace “Table 1205-4” with “Table 1205-6”.

**Page 12-11, Subarticle 1205-8(C), line 25**, replace “Table 1205-5” with “Table 1205-7”.

#### **Division 15**

**Page 15-6, Subarticle 1510-3(B), after line 21**, replace the allowable leakage formula with the following:  $W = LD\sqrt{P} \div 148,000$

**Page 15-6, Subarticle 1510-3(B), line 32**, delete “may be performed concurrently or” and replace with “shall be performed”.

**Page 15-17, Subarticle 1540-3(E), line 27**, delete “Type 1”.

#### **Division 17**

**Page 17-26, line 42, Subarticle 1731-3(D) Termination and Splicing within Interconnect Center**, delete this subarticle.

Revise the *2012 Roadway Standard Drawings* as follows:

**1633.01 Sheet 1 of 1, English Standard Drawing for Matting Installation**, replace “1633.01” with “1631.01”.

#### **PLANT AND PEST QUARANTINES:**

**(Imported Fire Ant, Gypsy Moth, Witchweed, And Other Noxious Weeds)**

(3-18-03)

Z-04a

#### **Within Quarantined Area**

This project may be within a county regulated for plant and/or pests. If the project or any part of the Contractor's operations is located within a quarantined area, thoroughly clean all equipment prior to moving out of the quarantined area. Comply with federal/state regulations by obtaining a certificate or limited permit for any regulated article moving from the quarantined area.

### **Originating in a Quarantined County**

Obtain a certificate or limited permit issued by the N.C. Department of Agriculture/United States Department of Agriculture. Have the certificate or limited permit accompany the article when it arrives at the project site.

### **Contact**

Contact the N.C. Department of Agriculture/United States Department of Agriculture at 1-800-206-9333, 919-733-6932, or <http://www.ncagr.com/plantind/> to determine those specific project sites located in the quarantined area or for any regulated article used on this project originating in a quarantined county.

### **Regulated Articles Include**

1. Soil, sand, gravel, compost, peat, humus, muck, and decomposed manure, separately or with other articles. This includes movement of articles listed above that may be associated with cut/waste, ditch pulling, and shoulder cutting.
2. Plants with roots including grass sod.
3. Plant crowns and roots.
4. Bulbs, corms, rhizomes, and tubers of ornamental plants.
5. Hay, straw, fodder, and plant litter of any kind.
6. Clearing and grubbing debris.
7. Used agricultural cultivating and harvesting equipment.
8. Used earth-moving equipment.
9. Any other products, articles, or means of conveyance, of any character, if determined by an inspector to present a hazard of spreading imported fire ant, gypsy moth, witchweed or other noxious weeds.

### **MINIMUM WAGES:**

(7-21-09)

Z-5

**FEDERAL:** The Fair Labor Standards Act provides that with certain exceptions every employer shall pay wages at the rate of not less than SEVEN DOLLARS AND TWENTY FIVE CENTS (\$7.25) per hour.

**STATE:** The North Carolina Minimum Wage Act provides that every employer shall pay to each of his employees, wages at a rate of not less than SEVEN DOLLARS AND TWENTY FIVE CENTS (\$7.25) per hour.

The minimum wage paid to all skilled labor employed on this contract shall be SEVEN DOLLARS AND TWENTY FIVE CENTS (\$7.25) per hour.

The minimum wage paid to all intermediate labor employed on this contract shall be SEVEN DOLLARS AND TWENTY FIVE CENTS (\$7.25) per hour.

The minimum wage paid to all unskilled labor on this contract shall be SEVEN DOLLARS AND TWENTY FIVE CENTS (\$7.25) per hour.

This determination of the intent of the application of this act to the contract on this project is the responsibility of the Contractor.

The Contractor shall have no claim against the Department of Transportation for any changes in the minimum wage laws, Federal or State. It is the responsibility of the Contractor to keep fully informed of all Federal and State Laws affecting his contract.

## **ON-THE-JOB TRAINING:**

(10-16-07) (Rev. 7-21-09)

Z-10

### **Description**

The North Carolina Department of Transportation will administer a custom version of the Federal On-the-Job Training (OJT) Program, commonly referred to as the Alternate OJT Program. All contractors (existing and newcomers) will be automatically placed in the Alternate Program. Standard OJT requirements typically associated with individual projects will no longer be applied at the project level. Instead, these requirements will be applicable on an annual basis for each contractor administered by the OJT Program Manager.

On the Job Training shall meet the requirements of 23 CFR 230.107 (b), 23 USC – Section 140, this provision and the On-the-Job Training Program Manual.

The Alternate OJT Program will allow a contractor to train employees on Federal, State and privately funded projects located in North Carolina. However, priority shall be given to training employees on NCDOT Federal-Aid funded projects.

### **Minorities and Women**

Developing, training and upgrading of minorities and women toward journeyman level status is a primary objective of this special training provision. Accordingly, the Contractor shall make every effort to enroll minority and women as trainees to the extent that such persons are available within a reasonable area of recruitment. This training commitment is not intended, and shall not be used, to discriminate against any applicant for training, whether a member of a minority group or not.

### **Assigning Training Goals**

The Department, through the OJT Program Manager, will assign training goals for a calendar year based on the contractors' past three years' activity and the contractors' anticipated upcoming year's activity with the Department. At the beginning of each year, all contractors eligible will be contacted by the Department to determine the number of trainees that will be assigned for the upcoming calendar year. At that time the Contractor shall enter into an agreement with the Department to provide a self-imposed on-the-job training program for the calendar year. This agreement will include a specific number of annual training goals agreed to by both parties. The number of training assignments may range from 1 to 15 per contractor per calendar year. The Contractor shall sign an agreement to fulfill their annual goal for the year. A sample agreement is available at [www.ncdot.org/business/ocs/ojt/](http://www.ncdot.org/business/ocs/ojt/).

## **Training Classifications**

The Contractor shall provide on-the-job training aimed at developing full journeyman level workers in the construction craft/operator positions. Preference shall be given to providing training in the following skilled work classifications:

Equipment Operators	Office Engineers
Truck Drivers	Estimators
Carpenters	Iron / Reinforcing Steel Workers
Concrete Finishers	Mechanics
Pipe Layers	Welders

The Department has established common training classifications and their respective training requirements that may be used by the contractors. However, the classifications established are not all-inclusive. Where the training is oriented toward construction applications, training will be allowed in lower-level management positions such as office engineers and estimators. Contractors shall submit new classifications for specific job functions that their employees are performing. The Department will review and recommend for acceptance to FHWA the new classifications proposed by contractors, if applicable. New classifications shall meet the following requirements:

Proposed training classifications are reasonable and realistic based on the job skill classification needs, and

The number of training hours specified in the training classification is consistent with common practices and provides enough time for the trainee to obtain journeyman level status.

The Contractor may allow trainees to be trained by a subcontractor provided that the Contractor retains primary responsibility for meeting the training and this provision is made applicable to the subcontract. However, only the Contractor will receive credit towards the annual goal for the trainee.

Where feasible, 25 percent of apprentices or trainees in each occupation shall be in their first year of apprenticeship or training. The number of trainees shall be distributed among the work classifications on the basis of the contractor's needs and the availability of journeymen in the various classifications within a reasonable area of recruitment.

No employee shall be employed as a trainee in any classification in which they have successfully completed a training course leading to journeyman level status or in which they have been employed as a journeyman.

## **Records and Reports**

The Contractor shall maintain enrollment, monthly and completion reports documenting company compliance under these contract documents. These documents and any other information as requested shall be submitted to the OJT Program Manager.

Upon completion and graduation of the program, the Contractor shall provide each trainee with a certification Certificate showing the type and length of training satisfactorily completed.

**Trainee Interviews**

All trainees enrolled in the program will receive an initial and Trainee/Post graduate interview conducted by the OJT program staff.

**Trainee Wages**

Contractors shall compensate trainees on a graduating pay scale based upon a percentage of the prevailing minimum journeyman wages (Davis-Bacon Act). Minimum pay shall be as follows:

- 60 percent of the journeyman wage for the first half of the training period
- 75 percent of the journeyman wage for the third quarter of the training period
- 90 percent of the journeyman wage for the last quarter of the training period

In no instance shall a trainee be paid less than the local minimum wage. The Contractor shall adhere to the minimum hourly wage rate that will satisfy both the NC Department of Labor (NCDOL) and the Department.

**Achieving or Failing to Meet Training Goals**

The Contractor will be credited for each trainee employed by him on the contract work who is currently enrolled or becomes enrolled in an approved program and who receives training for at least 50 percent of the specific program requirement. Trainees will be allowed to be transferred between projects if required by the Contractor’s scheduled workload to meet training goals.

If a contractor fails to attain their training assignments for the calendar year, they may be taken off the NCDOT’s Bidders List.

**Measurement and Payment**

No compensation will be made for providing required training in accordance with these contract documents.



VICINITY MAPS

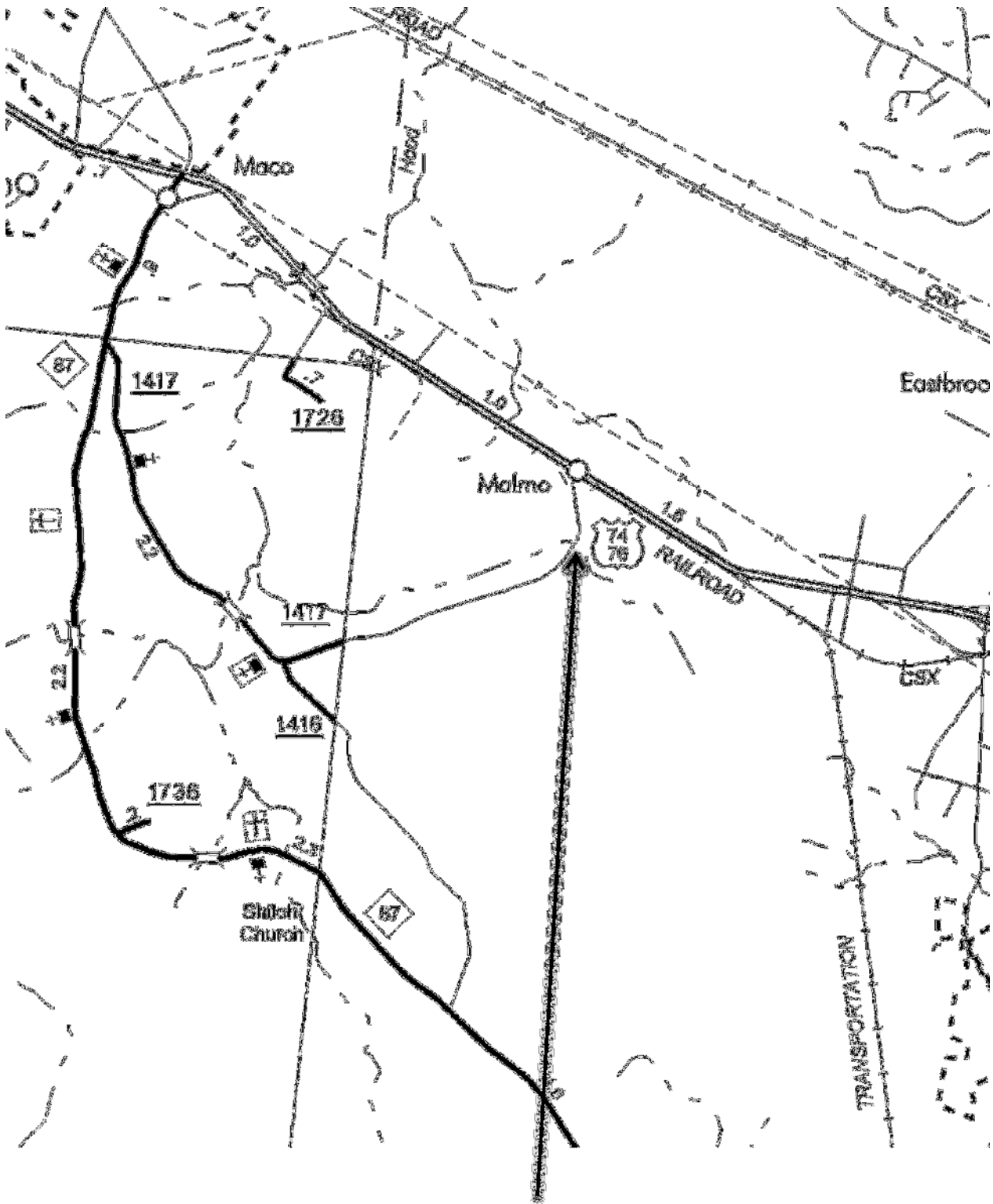

BRUNSWICK #092013 SR-1417 1.7 MILES EAST OF SR-1416

1 LINE @ 112" X 75" CMPA

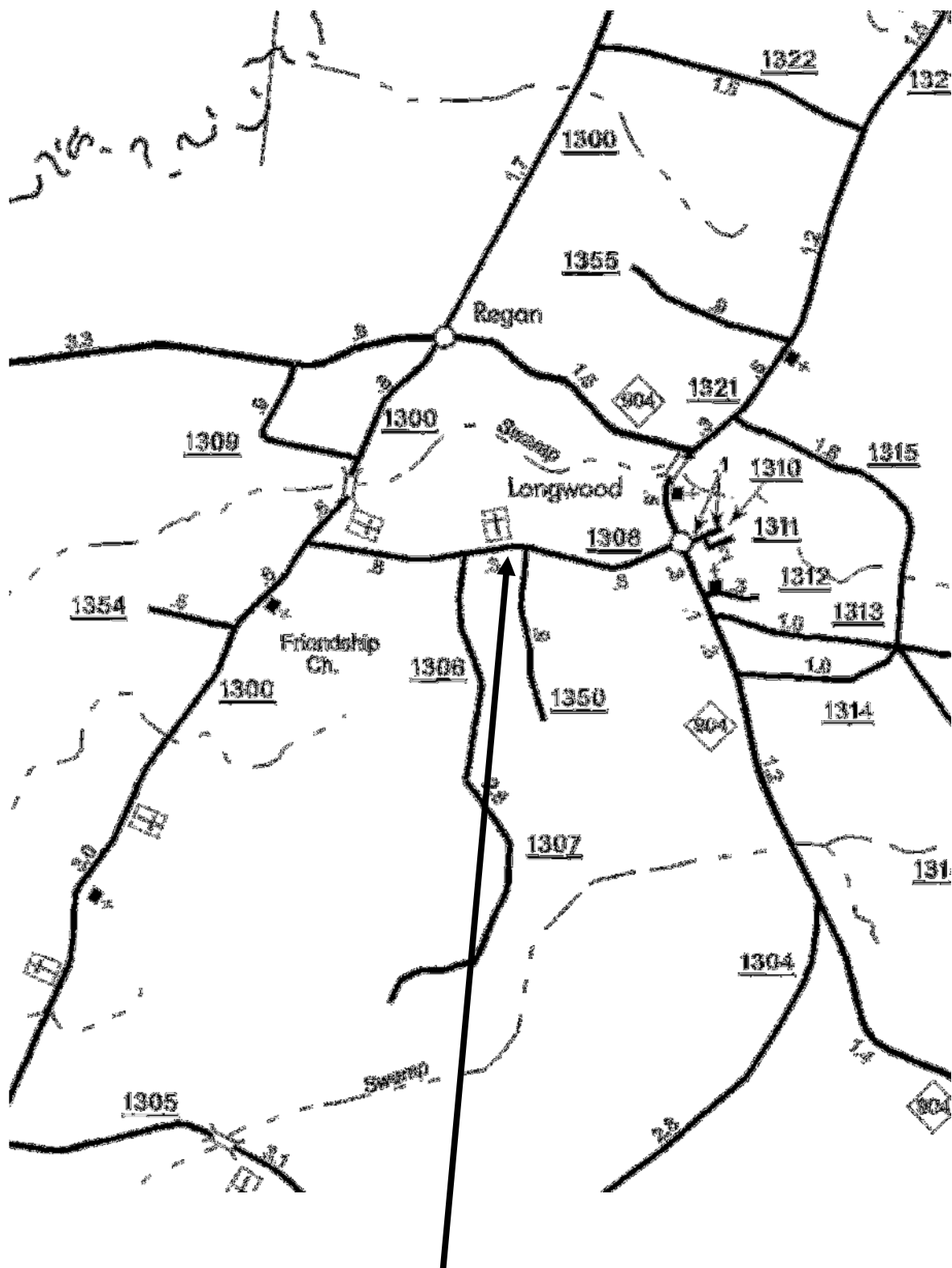

BRUNSWICK #092041 SR1308 0.9 MILES WEST OF NC 904

1 LINE @ 66" X 51" CMPA

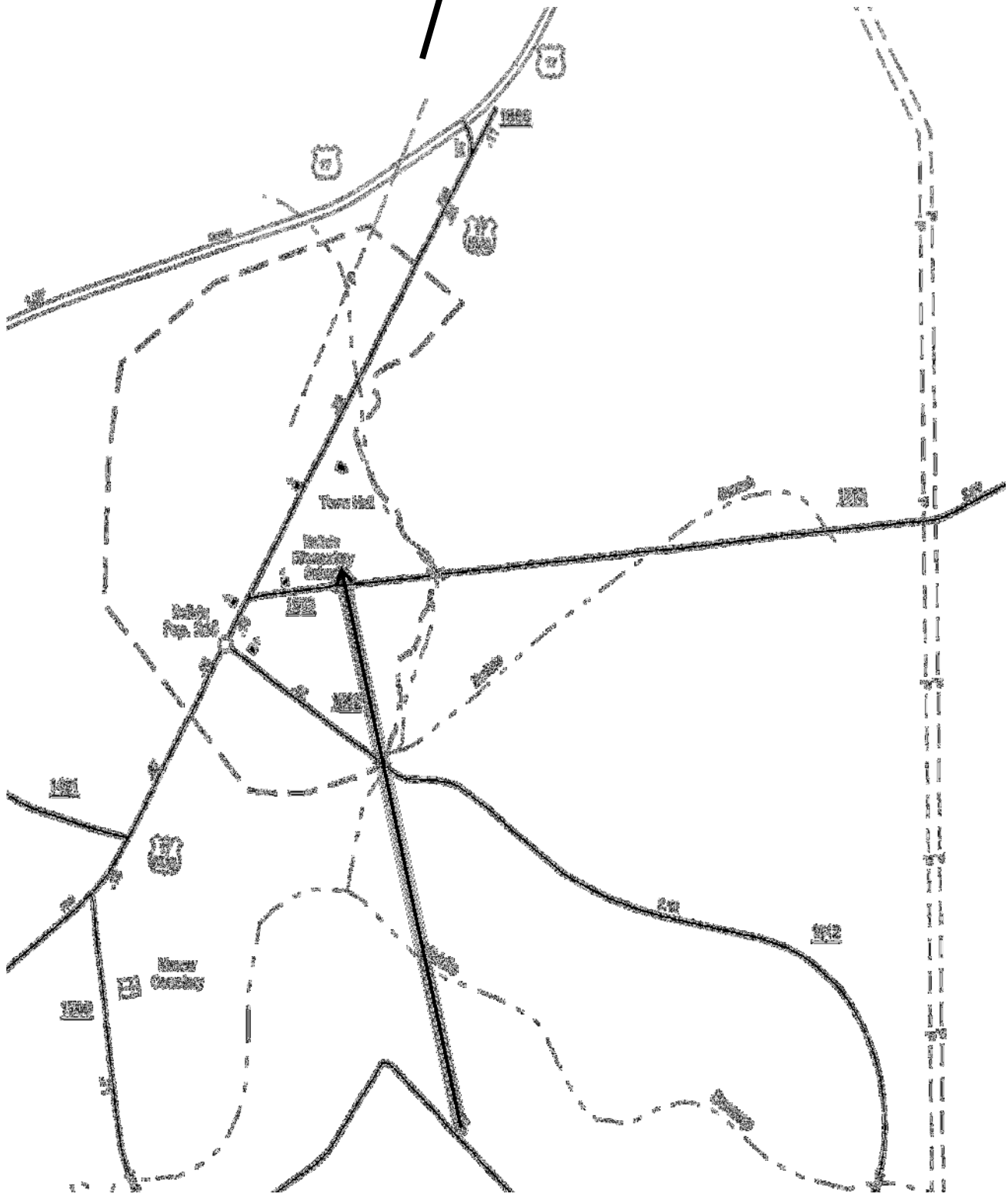

BRUNSWICK #092043 SR1513 0.8 MILES EAST OF US 17 BUS.

1 LINE @ 112" X 75" CMPA W/HEADWALL

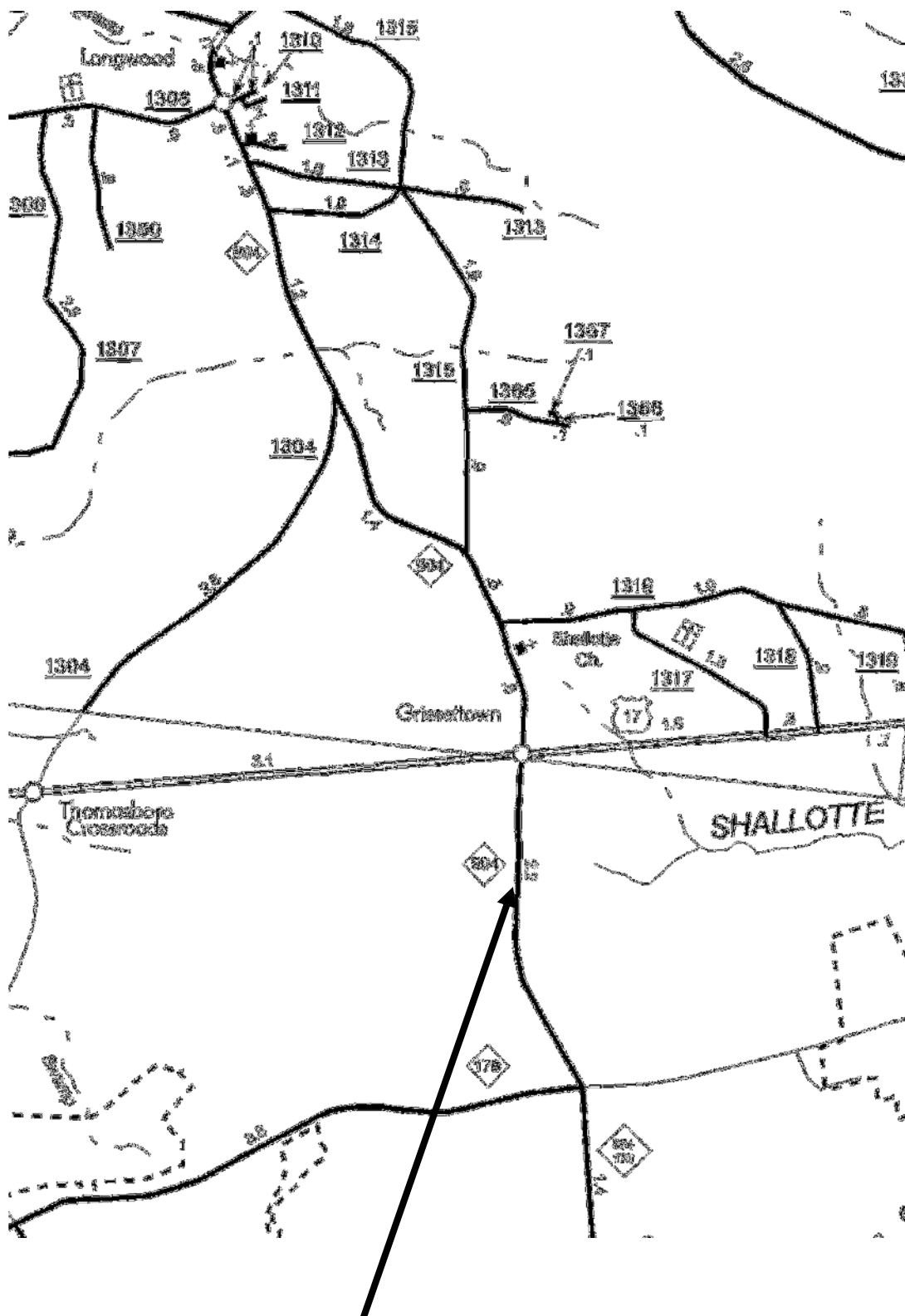

BRUNSWICK #092055 NC904 0.8 MILES SOUTH OF US 17

1 LINE @ 95" X 67" CMPA W/HEADWALL

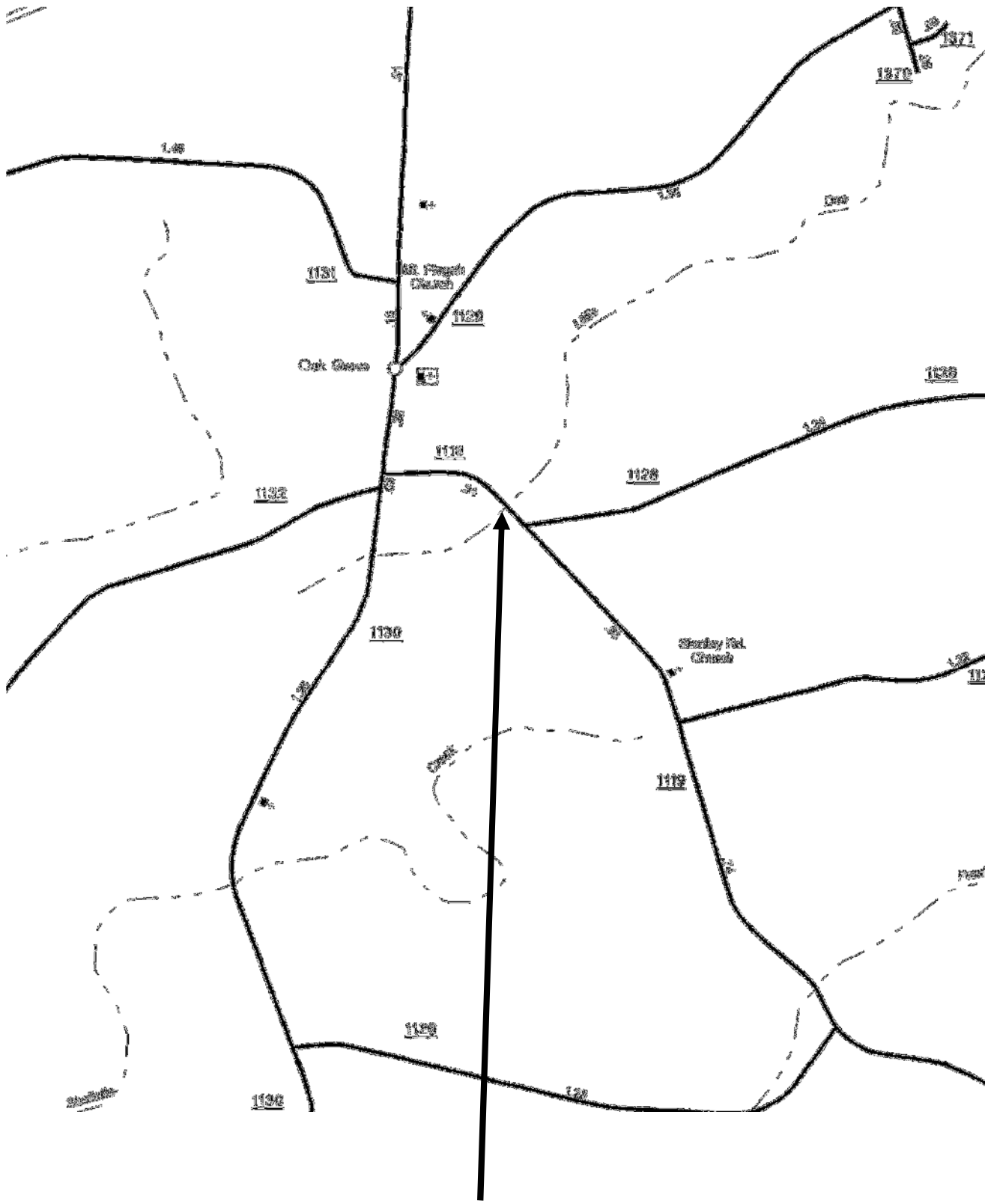

BRUNSWICK #092127 SR1119 0.1 MILES NORTH OF SR1128

1 LINE @ 60" W/HEADWALL

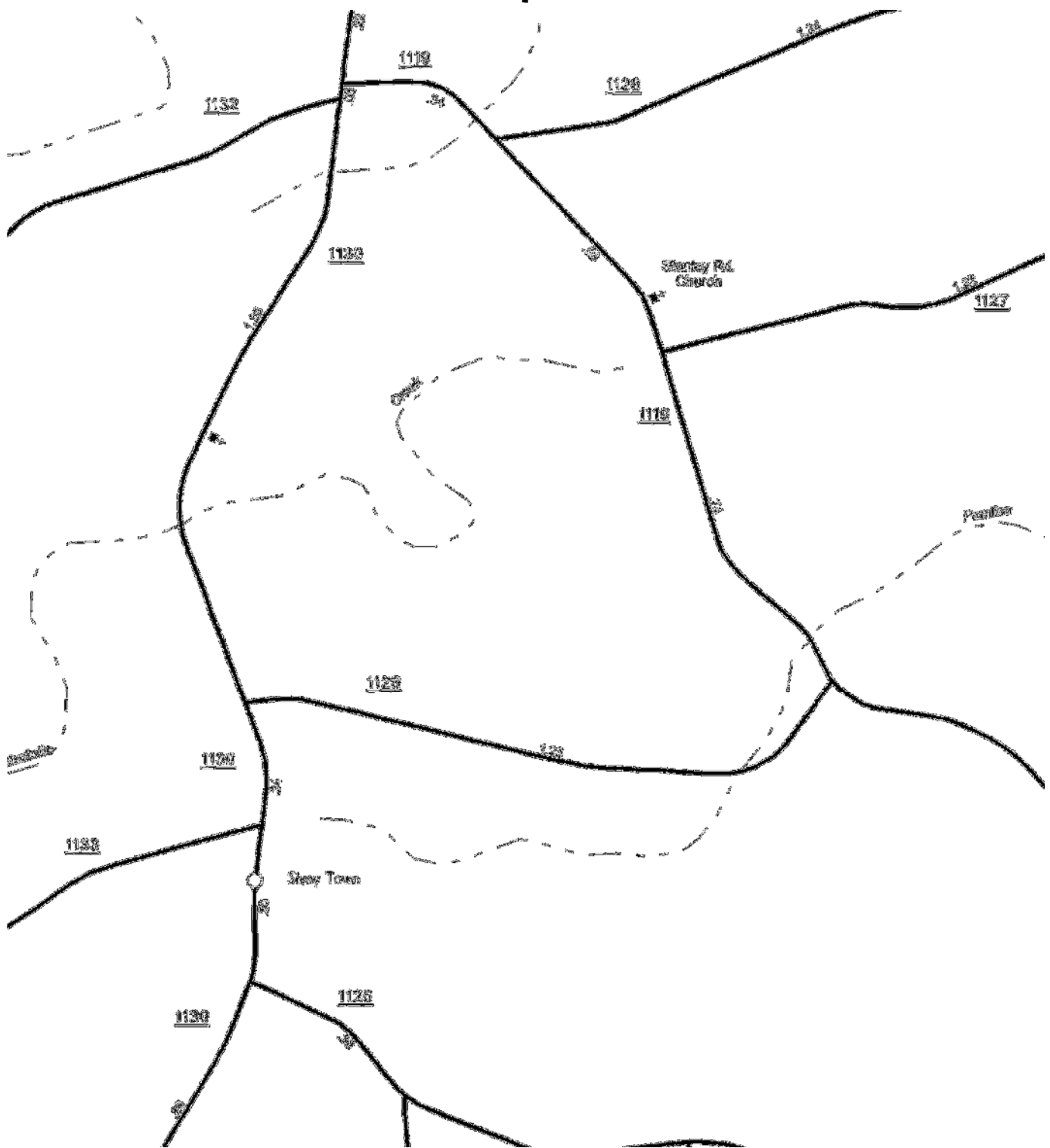

BRUNSWICK #092128 SR1128 0.3 MILES EAST OF SR1119

1 LINE @ 60" W/HEADWALL

# STRUCTURE DRAWINGS

SR-1417  
1.7 MILES EAST OF SR-1416  
092013

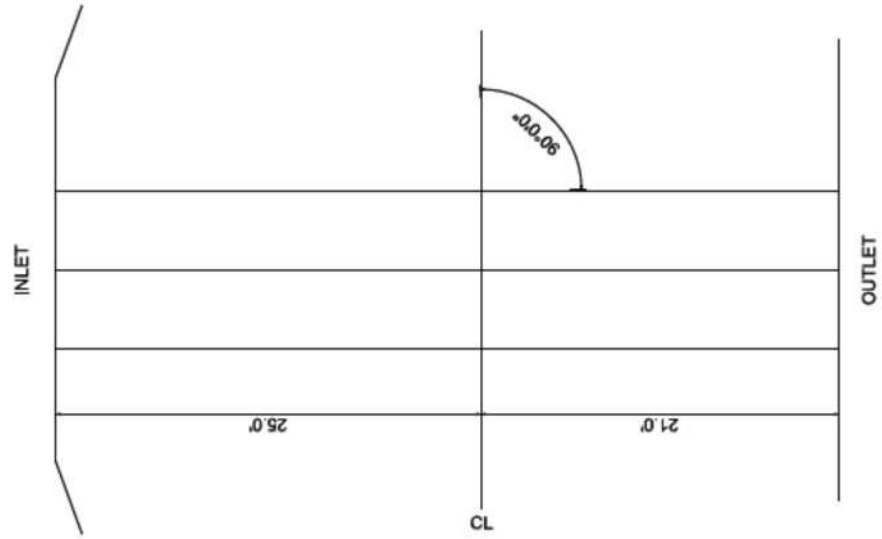

TOP OF WALL - 98.5'  
TAPER - 99.0'

TOP OF BAFFLE - 92.5'  
INLET INVERT - 92.0'  
BOTTOM OF WALL - 91.0'

TOP OF WALL - 98.5'  
TAPER - 99.0'

OUTLET INVERT - 91.5'  
BOTTOM OF WALL - 90.5'

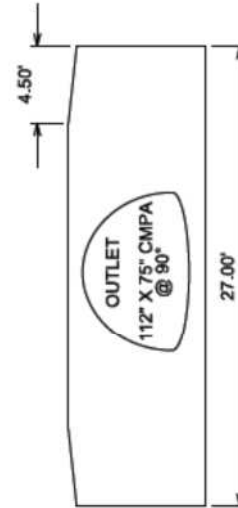
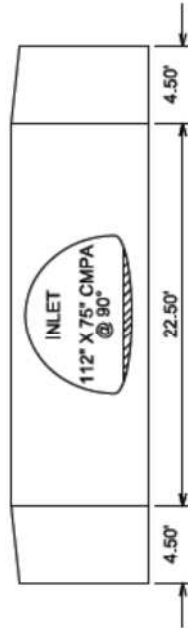

SR-1308  
 0.9 MILES WEST OF NC 904  
 092041

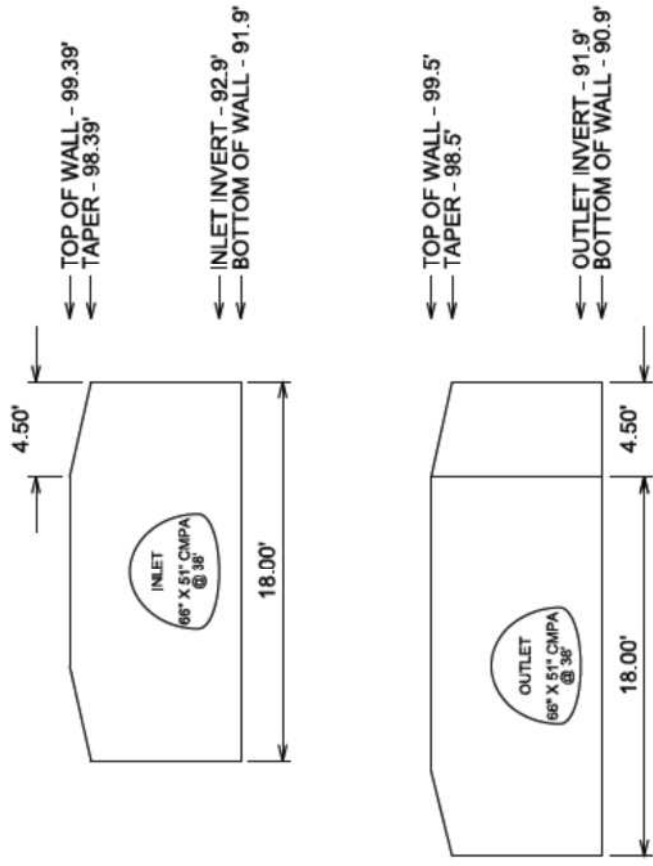
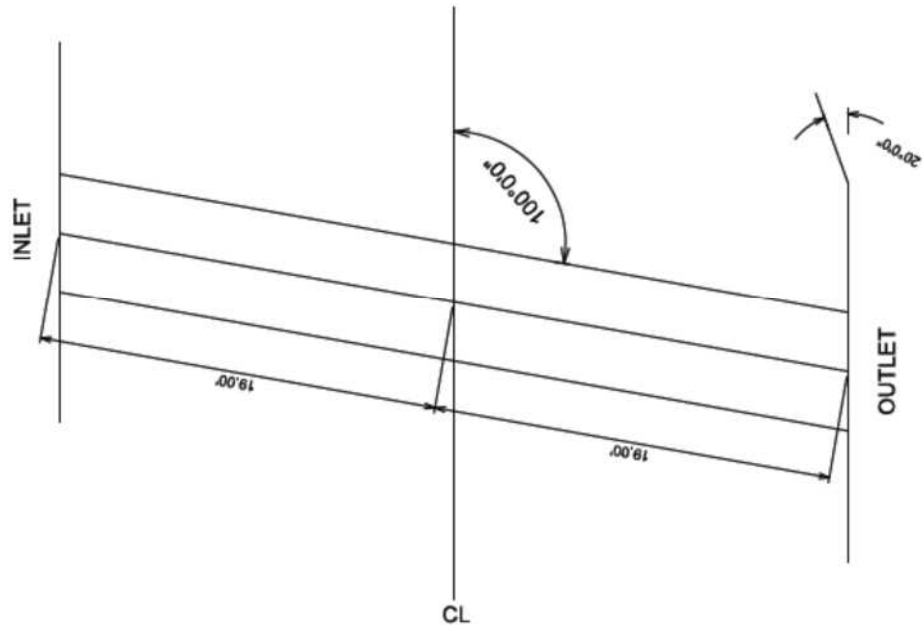



SR-1513  
 0.8 MILES EAST OF US 17 BUS.  
 092043

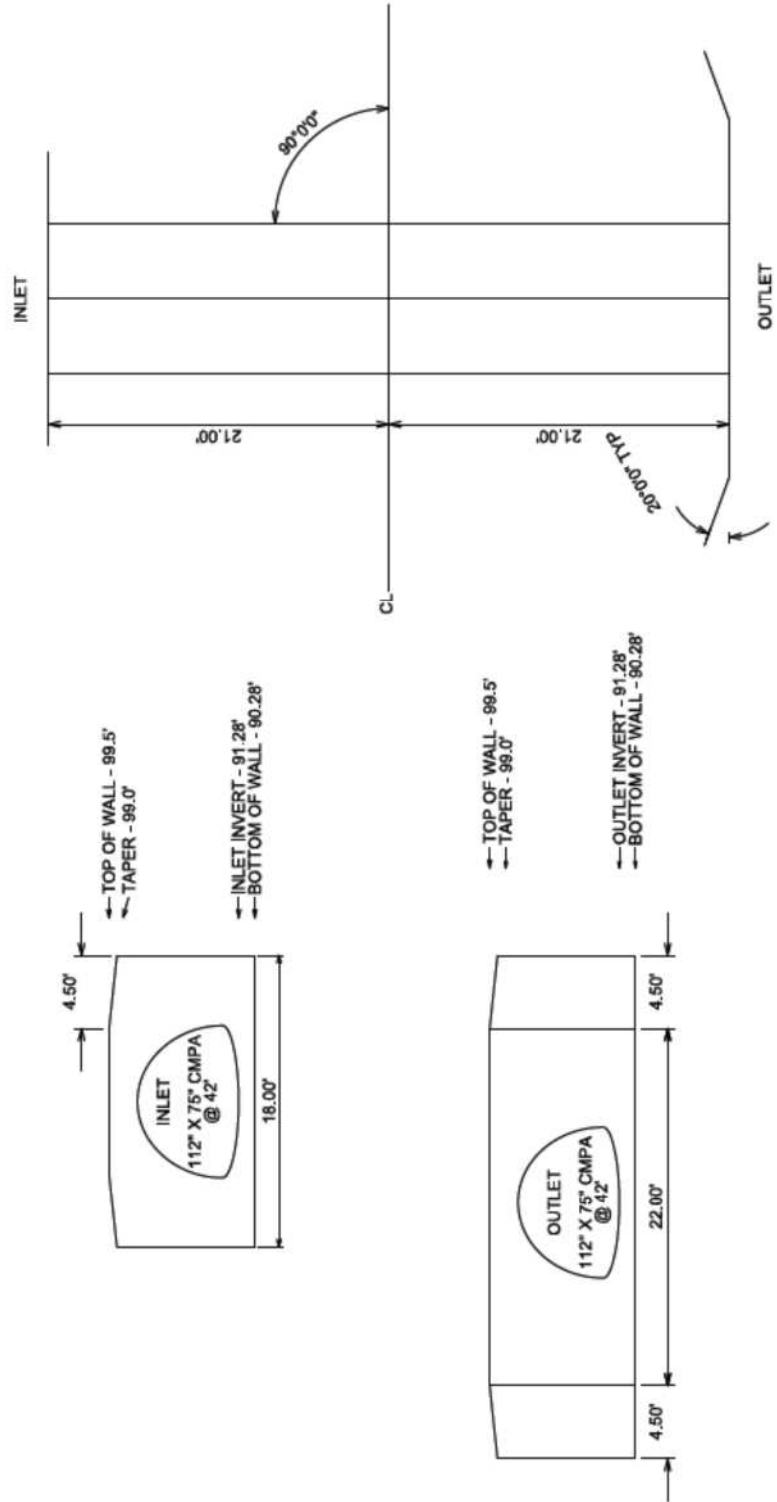

NC 904  
 0.8 MILES SOUTH OF US 17  
 092055

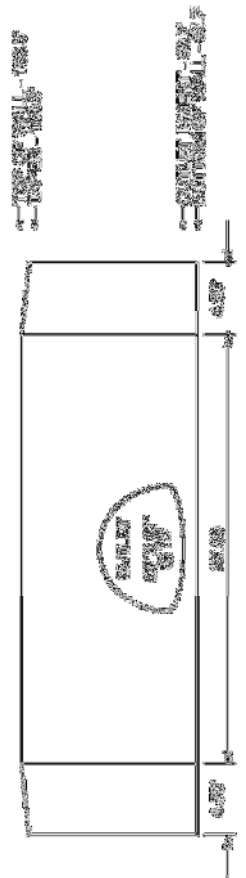
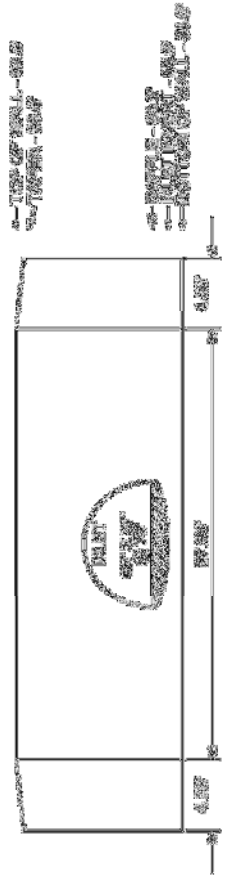
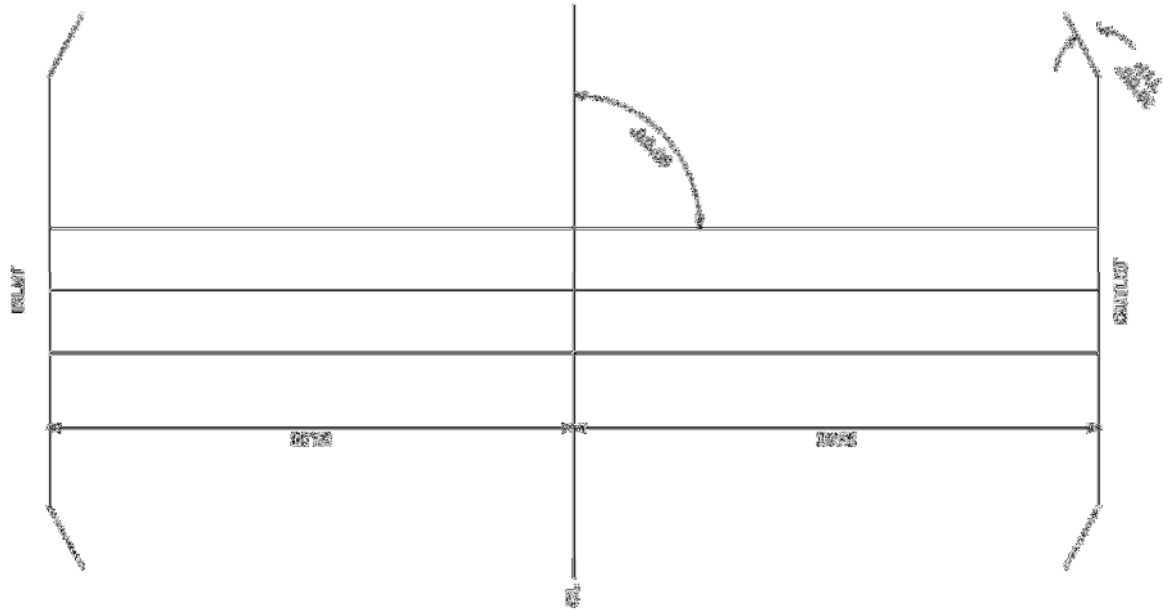

SR-1119  
 0.1 MILES NORTH OF SR-1128  
 092127

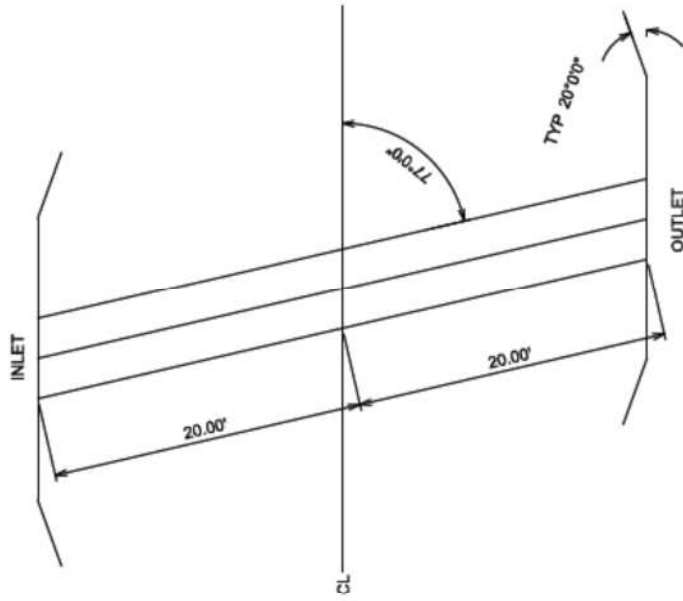

TOP OF WALL - 98.97'  
 TAPER - 98.3'

INLET INVERT - 91.5'  
 BOTTOM OF WALL - 90.5'

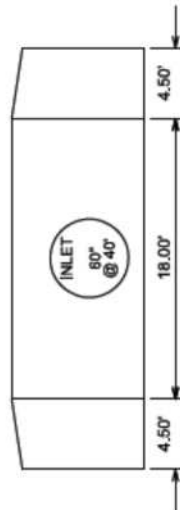

TOP OF WALL - 99.5'  
 TAPER - 99.0'

OUTLET INVERT - 91.1'  
 BOTTOM OF WALL - 90.1'

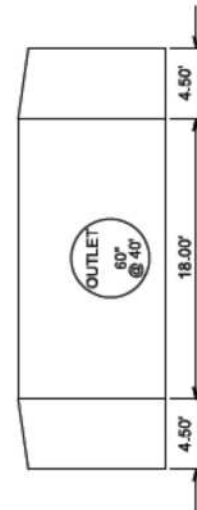

SR-1128  
 0.3 MILES EAST OF SR-1119  
 092128

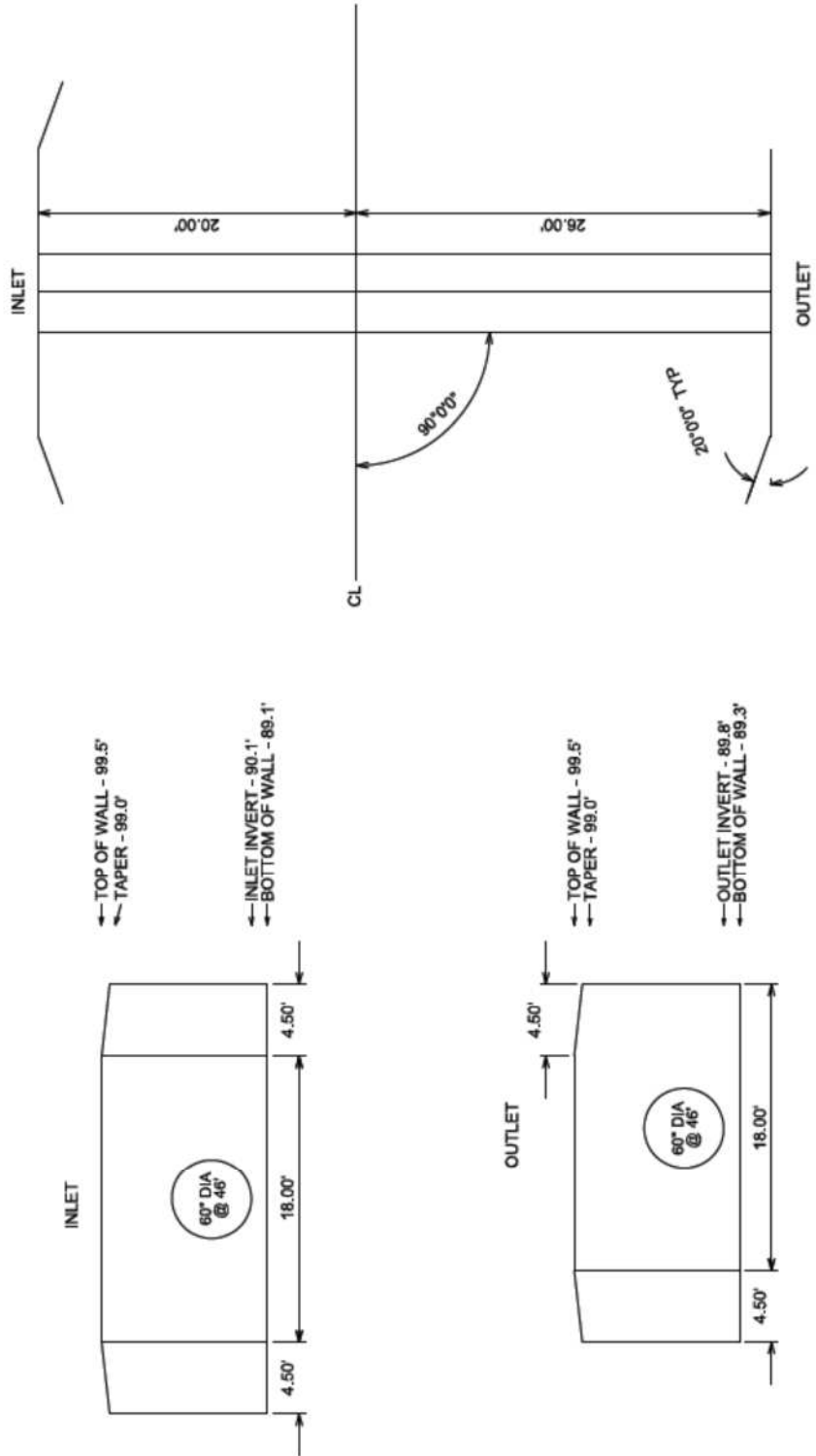

## **GENERAL ALUMINUM STRUCTURE REQUIREMENTS**

All items are incidental to Pipe and Headwalls (Assembly and Installation)

- ALL MATERIALS SHALL MEET THE REQUIREMENT OF THE JANUARY 1, 2012 NORTH CAROLINA DEPARTMENT OF TRANSPORTATION STANDARD SPECIFICATIONS FOR ROADS AND STRUCTURES.
- Pipe material shall be made of aluminum alloy and in dimensions per the standard specifications and hydraulic recommendations.
- Poor quality of workmanship of any materials supplied will constitute grounds for the structure being rejected.
- Manufacturer's representative, with at least two (2) years of experience in the installation of the type of structure, is required to provide technical assistance with the assembly of structure and headwalls as well as being on site during the installation and backfilling of pipe with headwalls through completion.
- Detailed shop drawings and design calculations shall be submitted for acceptance. The supplier shall provide a design that meets the requirements of AASHTO and is sealed by a NC registered Professional Engineer.
- Use arch shaped structures when possible in the vicinity of dwellings to lower the stormwater elevation.
- Headwall locations shall be at or beyond the shoulder point.
- Headwalls will be required on the inlet and outlet of all pipes.
- All headwalls shall be parallel to the roadway.
- Bottom of headwall elevation shall be 1' below invert.
- Headwall invert elevations shall be 1' below streambed.
- Headwall foundation shall be undercut and backfilled with #57 stone 1' below bottom of headwall elevation.
- Wing walls shall be required if ditches are adjacent to the structure.
- An NCDOT approved soil engineering fabric shall be required on top of the #57 stone prior to backfilling of the roadbed.
- Pipe is to be fully welded inside and out to headwalls using two root welds and two finish welds on either side of the wall. All finish welds are to be ground to a smooth finish.
- Headwall and pipe are to be reinforced per AASHTO specifications and structural engineer's requirements.
- All hardware including nuts, bolts, washers, rods, etc. shall be hot dipped galvanized.

- A 2' wide band and a continuous 3/8" thick x 2' wide flat gasket made of closed cell neoprene rubber which upon assembly provides a watertight seal at each joint will be required.
- All holes or tears in the pipe must be repaired prior to backfilling.
- Pipe bed will be undercut and backfilled with #57 stone 1' below pipe invert elevations.
- Backfill material shall be #57 stone from 1' below streambed elevation to 1' above the top and sides.
- Supplier to include all necessary wale beams, headwall cap, continuous flat gaskets and galvanized steel tieback rods with dma plates and adjustable hot dip galvanized turnbuckles.
- Pipe sections and bands shall be assembled and alphanumerically / alignment match-marked at the plant site before shipping to verify fit.
- Bands shall be installed onto the pipe sections prior to shipping.
- Pipe manufacturer must provide certification of the measured dimensions of the pipe, bands and the continuous flat gaskets. Certification must state that the bands and the gaskets have been pre-fitted and will securely tighten around the supplied pipe. Certification of the dimensions must be signed by the manufacture's representative and dated.
  - EXAMPLE:** Supplied pipe measures \_\_\_\_ inches in diameter. Supplied bands and the continuous flat gaskets measure \_\_\_\_ inches in length and will securely fasten pipe sections, without field modification.
  - Signature \_\_\_\_\_
  - Date: \_\_\_\_\_
- Within 14 days after award, the bidder shall submit to the Division Bridge Program Manager for approval, a NC licensed professional engineer detailed drawing, stamp, and wall calculations provided by an independent engineering firm.

**NCDOT APPROVED PIPE AND HEADWALL VENDORS**

CONTECH

PHONE # 919-889-0878

CONTACT PERSON: RAHN SUTTON

LANE ENTERPRISES, INC.

PHONE # 540-674-4645

CONTACT PERSON: PAUL VAUGHN

POMONA PIPE INC.

PHONE # 336-255-2655

CONTACT PERSON: DON JOYCE

## PIPE INFORMATION

<b>LOCATION</b>	<b>EXISTING</b>	<b>PROPOSED</b>	<b>PROPOSED INVERT ELEV.</b>
Pipe # 092013	1-55' line @ 60" CMP	1-46' line @ 112" x 75" Alum. CMPA	Inlet-92.0 Outlet-91.5
Pipe # 092041	1-49' line @ 60" x 46" CMPA	1-38' line @ 66" x 51" CMPA	Inlet-92.9 Outlet-91.9
Pipe # 092043	1-36.5' line @ 60" CMP	1-42' line @ 112" x 75" CMPA	Inlet-91.28 Outlet-91.28
Pipe # 092055	1-68' line @ 72" CMP	1-70' line @ 95" x 67" CMPA	Inlet-89.9 Outlet-88.7
Pipe # 092127	1-59' line @ 60" CMP	1-40' line @ 60" CMPA	Inlet-91.5 Outlet-91.1
Pipe # 092128	1-50' line @ 54" CMP	1-46' line @ 60" CMPA	Inlet-90.1 Outlet-89.8



**TYPICAL SECTION**

Typical Section

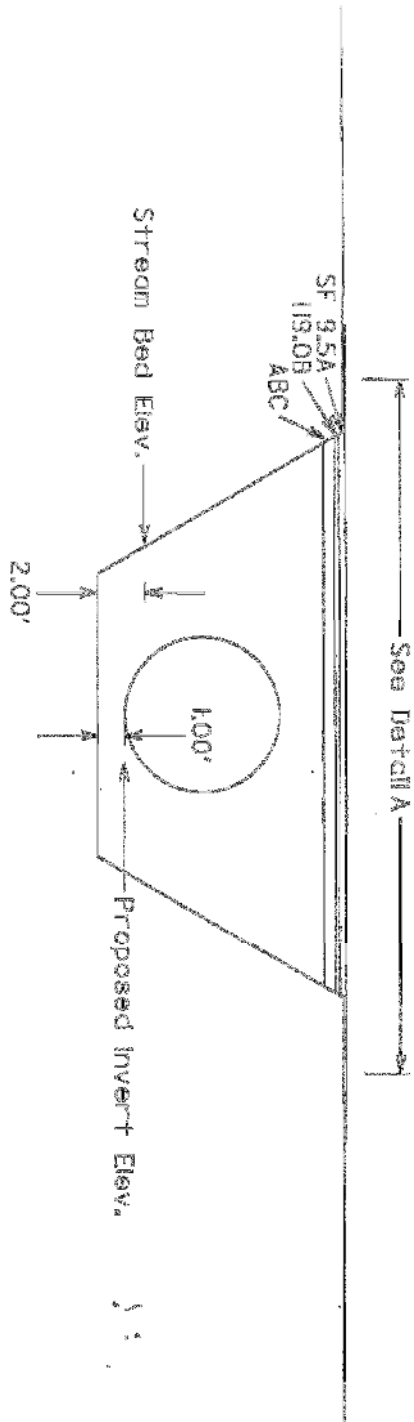

Detail A

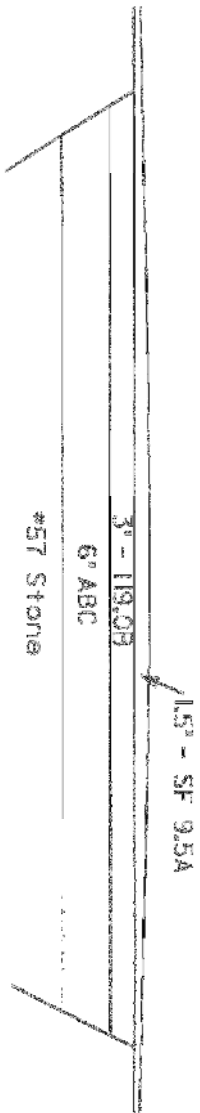

# BYPASS PUMPING TYPICAL

## MANAGING THE WATERCOURSE: BYPASS PUMPING

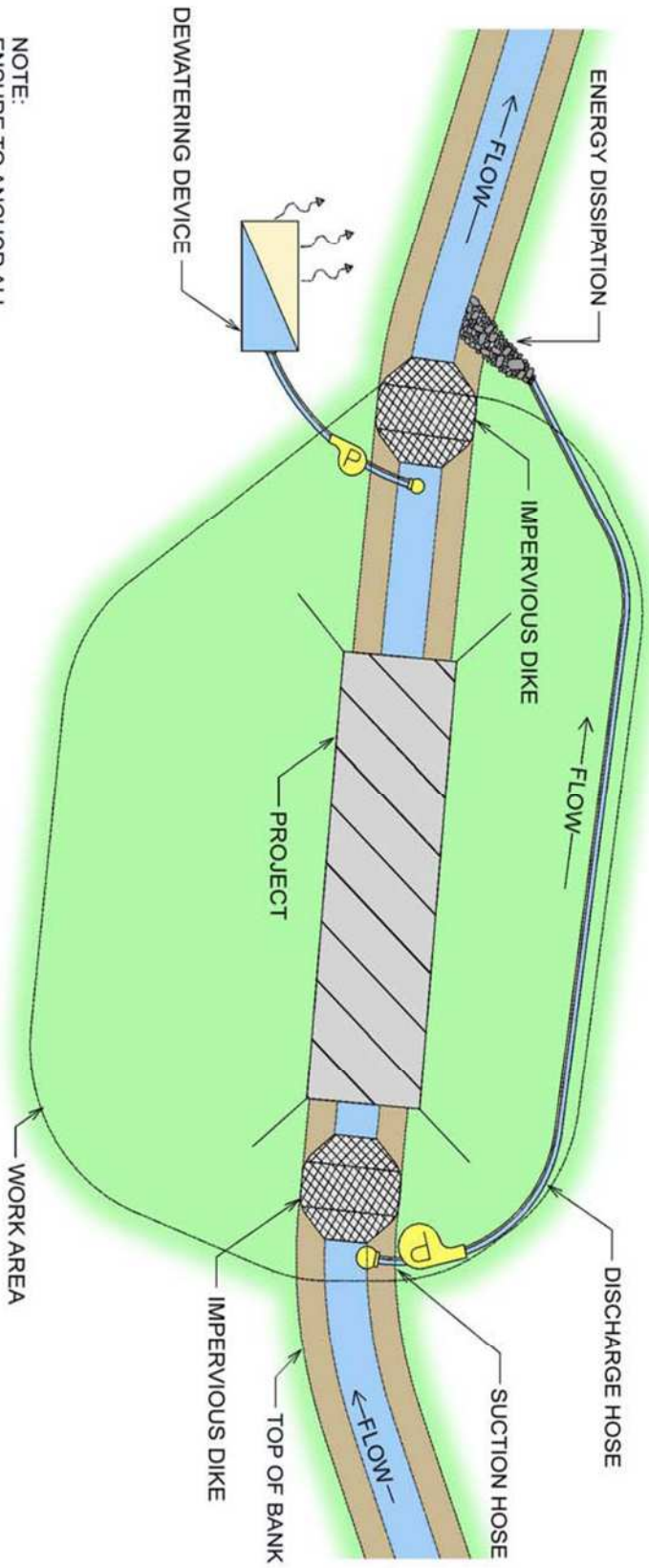

NOTE:  
ENSURE TO ANCHOR ALL  
PUMPS AND PIPES SECURELY.

NORTH CAROLINA DEPARTMENT OF TRANSPORTATION  
AUGUST 2003

BMPs FOR CONSTRUCTION AND MAINTENANCE ACTIVITIES

**EXECUTION OF BID  
NON-COLLUSION AFFIDAVIT, DEBARMENT CERTIFICATION AND GIFT BAN CERTIFICATION  
CORPORATION**

The person executing the bid, on behalf of the Bidder, being duly sworn, solemnly swears (or affirms) that neither he, nor any official, agent or employee of the bidder has entered into any agreement, participated in any collusion, or otherwise taken any action which is in restraint of free competitive bidding in connection with any bid or contract, that the bidder has not been convicted of violating *N.C.G.S. § 133-24* within the last three years, and that the Bidder intends to do the work with its own bonafide employees or subcontractors and is not bidding for the benefit of another contractor.

In addition, execution of this bid in the proper manner also constitutes the Bidder's certification of status under penalty of perjury under the laws of the United States in accordance with the Debarment Certification attached, provided that the Debarment Certification also includes any required statements concerning exceptions that are applicable.

*N.C.G.S. § 133-32* and Executive Order 24 prohibit the offer to, or acceptance by, any State Employee of any gift from anyone with a contract with the State, or from any person seeking to do business with the State. By execution of any response in this procurement, you attest, for your entire organization and its employees or agents, that you are not aware that any such gift has been offered, accepted, or promised by any employees of your organization.

**SIGNATURE OF CONTRACTOR**

\_\_\_\_\_ Full name of Corporation

\_\_\_\_\_ Address as Prequalified

Attest \_\_\_\_\_ By \_\_\_\_\_  
Secretary/Assistant Secretary President/Vice President/Assistant Vice President  
*Select appropriate title Select appropriate title*

\_\_\_\_\_ Print or type Signer's name

\_\_\_\_\_ Print or type Signer's name

**CORPORATE SEAL**

**AFFIDAVIT MUST BE NOTARIZED**

Subscribed and sworn to before me this the  
\_\_\_\_\_ day of \_\_\_\_\_ 20\_\_.

**NOTARY SEAL**

\_\_\_\_\_ Signature of Notary Public

of \_\_\_\_\_ County

State of \_\_\_\_\_

My Commission Expires: \_\_\_\_\_

**EXECUTION OF BID  
NON-COLLUSION AFFIDAVIT, DEBARMENT CERTIFICATION AND GIFT BAN CERTIFICATION  
PARTNERSHIP**

The person executing the bid, on behalf of the Bidder, being duly sworn, solemnly swears (or affirms) that neither he, nor any official, agent or employee of the bidder has entered into any agreement, participated in any collusion, or otherwise taken any action which is in restraint of free competitive bidding in connection with any bid or contract, that the bidder has not been convicted of violating *N.C.G.S. § 133-24* within the last three years, and that the Bidder intends to do the work with its own bonafide employees or subcontractors and is not bidding for the benefit of another contractor.

In addition, execution of this bid in the proper manner also constitutes the Bidder's certification of status under penalty of perjury under the laws of the United States in accordance with the Debarment Certification attached, provided that the Debarment Certification also includes any required statements concerning exceptions that are applicable.

*N.C.G.S. § 133-32* and Executive Order 24 prohibit the offer to, or acceptance by, any State Employee of any gift from anyone with a contract with the State, or from any person seeking to do business with the State. By execution of any response in this procurement, you attest, for your entire organization and its employees or agents, that you are not aware that any such gift has been offered, accepted, or promised by any employees of your organization.

**SIGNATURE OF CONTRACTOR**

_____	
Full Name of Partnership	
_____	
Address as Prequalified	
_____	By _____
Signature of Witness	Signature of Partner
_____	_____
Print or type Signer's name	Print or type Signer's name

**AFFIDAVIT MUST BE NOTARIZED**

Subscribed and sworn to before me this the \_\_\_\_\_ day of \_\_\_\_\_ 20\_\_.

**NOTARY SEAL**

\_\_\_\_\_  
Signature of Notary Public

of \_\_\_\_\_ County

State of \_\_\_\_\_

My Commission Expires: \_\_\_\_\_

**EXECUTION OF BID  
NON-COLLUSION AFFIDAVIT, DEBARMENT CERTIFICATION AND GIFT BAN CERTIFICATION  
LIMITED LIABILITY COMPANY**

The person executing the bid, on behalf of the Bidder, being duly sworn, solemnly swears (or affirms) that neither he, nor any official, agent or employee of the bidder has entered into any agreement, participated in any collusion, or otherwise taken any action which is in restraint of free competitive bidding in connection with any bid or contract, that the bidder has not been convicted of violating *N.C.G.S. § 133-24* within the last three years, and that the Bidder intends to do the work with its own bonafide employees or subcontractors and is not bidding for the benefit of another contractor.

In addition, execution of this bid in the proper manner also constitutes the Bidder's certification of status under penalty of perjury under the laws of the United States in accordance with the Debarment Certification attached, provided that the Debarment Certification also includes any required statements concerning exceptions that are applicable.

*N.C.G.S. § 133-32* and Executive Order 24 prohibit the offer to, or acceptance by, any State Employee of any gift from anyone with a contract with the State, or from any person seeking to do business with the State. By execution of any response in this procurement, you attest, for your entire organization and its employees or agents, that you are not aware that any such gift has been offered, accepted, or promised by any employees of your organization.

**SIGNATURE OF CONTRACTOR**

_____	
Full Name of Firm	
_____	
Address as Prequalified	
_____	Signature of Manager
Signature of Witness	_____
	Individually
_____	_____
Print or type Signer's name	Print or type Signer's Name

**AFFIDAVIT MUST BE NOTARIZED**

Subscribed and sworn to before me this the \_\_\_\_\_ day of \_\_\_\_\_ 20\_\_.

**NOTARY SEAL**

\_\_\_\_\_  
Signature of Notary Public

of \_\_\_\_\_ County

State of \_\_\_\_\_

My Commission Expires: \_\_\_\_\_

**EXECUTION OF BID  
NON-COLLUSION AFFIDAVIT, DEBARMENT CERTIFICATION AND GIFT BAN CERTIFICATION  
JOINT VENTURE (2) or (3)**

The person executing the bid, on behalf of the Bidder, being duly sworn, solemnly swears (or affirms) that neither he, nor any official, agent or employee of the bidder has entered into any agreement, participated in any collusion, or otherwise taken any action which is in restraint of free competitive bidding in connection with any bid or contract, that the bidder has not been convicted of violating *N.C.G.S. § 133-24* within the last three years, and that the Bidder intends to do the work with its own bonafide employees or subcontractors and is not bidding for the benefit of another contractor.

In addition, execution of this bid in the proper manner also constitutes the Bidder's certification of status under penalty of perjury under the laws of the United States in accordance with the Debarment Certification attached, provided that the Debarment Certification also includes any required statements concerning exceptions that are applicable.

*N.C.G.S. § 133-32* and Executive Order 24 prohibit the offer to, or acceptance by, any State Employee of any gift from anyone with a contract with the State, or from any person seeking to do business with the State. By execution of any response in this procurement, you attest, for your entire organization and its employees or agents, that you are not aware that any such gift has been offered, accepted, or promised by any employees of your organization.

**SIGNATURE OF CONTRACTOR**

Instructions: **2 Joint Venturers** Fill in lines (1), (2) and (3) and execute. **3 Joint Venturers** Fill in lines (1), (2), (3) and (4) and execute. On Line (1), fill in the name of the Joint Venture Company. On Line (2), fill in the name of one of the joint venturers and execute below in the appropriate manner. On Line (3), print or type the name of the other joint venturer and execute below in the appropriate manner. On Line (4), fill in the name of the third joint venturer, if applicable and execute below in the appropriate manner.

(1) \_\_\_\_\_  
Name of Joint Venture

(2) \_\_\_\_\_  
Name of Contractor

\_\_\_\_\_  
Address as Prequalified

\_\_\_\_\_  
Signature of Witness or Attest By \_\_\_\_\_  
Signature of Contractor

\_\_\_\_\_  
Print or type Signer's name \_\_\_\_\_  
Print or type Signer's name

*If Corporation, affix Corporate Seal* and

(3) \_\_\_\_\_  
Name of Contractor

\_\_\_\_\_  
Address as Prequalified

\_\_\_\_\_  
Signature of Witness or Attest By \_\_\_\_\_  
Signature of Contractor

\_\_\_\_\_  
Print or type Signer's name \_\_\_\_\_  
Print or type Signer's name

*If Corporation, affix Corporate Seal* and

(4) \_\_\_\_\_  
Name of Contractor (for 3 Joint Venture only)

\_\_\_\_\_  
Address as Prequalified

\_\_\_\_\_  
Signature of Witness or Attest By \_\_\_\_\_  
Signature of Contractor

\_\_\_\_\_  
Print or type Signer's name \_\_\_\_\_  
Print or type Signer's name

*If Corporation, affix Corporate Seal*

**NOTARY SEAL**

*Affidavit must be notarized for Line (2)*

Subscribed and sworn to before me this \_\_\_\_\_ day of \_\_\_\_\_ 20\_\_\_\_

\_\_\_\_\_  
Signature of Notary Public  
of \_\_\_\_\_ County

State of \_\_\_\_\_

My Commission Expires: \_\_\_\_\_

**NOTARY SEAL**

*Affidavit must be notarized for Line (3)*

Subscribed and sworn to before me this \_\_\_\_\_ day of \_\_\_\_\_ 20\_\_\_\_

\_\_\_\_\_  
Signature of Notary Public  
of \_\_\_\_\_ County

State of \_\_\_\_\_

My Commission Expires: \_\_\_\_\_

**NOTARY SEAL**

*Affidavit must be notarized for Line (4)*

Subscribed and sworn to before me this \_\_\_\_\_ day of \_\_\_\_\_ 20\_\_\_\_

\_\_\_\_\_  
Signature of Notary Public  
of \_\_\_\_\_ County

State of \_\_\_\_\_

My Commission Expires: \_\_\_\_\_

**EXECUTION OF BID  
NON-COLLUSION AFFIDAVIT, DEBARMENT CERTIFICATION AND GIFT BAN CERTIFICATION**

**INDIVIDUAL DOING BUSINESS UNDER A FIRM NAME**

The person executing the bid, on behalf of the Bidder, being duly sworn, solemnly swears (or affirms) that neither he, nor any official, agent or employee of the bidder has entered into any agreement, participated in any collusion, or otherwise taken any action which is in restraint of free competitive bidding in connection with any bid or contract, that the bidder has not been convicted of violating *N.C.G.S. § 133-24* within the last three years, and that the Bidder intends to do the work with its own bonafide employees or subcontractors and is not bidding for the benefit of another contractor.

In addition, execution of this bid in the proper manner also constitutes the Bidder's certification of status under penalty of perjury under the laws of the United States in accordance with the Debarment Certification attached, provided that the Debarment Certification also includes any required statements concerning exceptions that are applicable.

*N.C.G.S. § 133-32* and Executive Order 24 prohibit the offer to, or acceptance by, any State Employee of any gift from anyone with a contract with the State, or from any person seeking to do business with the State. By execution of any response in this procurement, you attest, for your entire organization and its employees or agents, that you are not aware that any such gift has been offered, accepted, or promised by any employees of your organization.

**SIGNATURE OF CONTRACTOR**

Name of Contractor

\_\_\_\_\_ Individual name

Trading and doing business as

\_\_\_\_\_ Full name of Firm

\_\_\_\_\_ Address as Prequalified

\_\_\_\_\_ Signature of Witness

\_\_\_\_\_ Signature of Contractor, Individually

\_\_\_\_\_ Print or type Signer's name

\_\_\_\_\_ Print or type Signer's name

**AFFIDAVIT MUST BE NOTARIZED**

Subscribed and sworn to before me this the

**NOTARY SEAL**

\_\_\_\_\_ day of \_\_\_\_\_ 20\_\_.

\_\_\_\_\_ Signature of Notary Public

of \_\_\_\_\_ County

State of \_\_\_\_\_

My Commission Expires: \_\_\_\_\_

**EXECUTION OF BID  
NON-COLLUSION AFFIDAVIT, DEBARMENT CERTIFICATION AND GIFT BAN CERTIFICATION**

**INDIVIDUAL DOING BUSINESS IN HIS OWN NAME**

The person executing the bid, on behalf of the Bidder, being duly sworn, solemnly swears (or affirms) that neither he, nor any official, agent or employee of the bidder has entered into any agreement, participated in any collusion, or otherwise taken any action which is in restraint of free competitive bidding in connection with any bid or contract, that the bidder has not been convicted of violating *N.C.G.S. § 133-24* within the last three years, and that the Bidder intends to do the work with its own bonafide employees or subcontractors and is not bidding for the benefit of another contractor.

In addition, execution of this bid in the proper manner also constitutes the Bidder's certification of status under penalty of perjury under the laws of the United States in accordance with the Debarment Certification attached, provided that the Debarment Certification also includes any required statements concerning exceptions that are applicable.

*N.C.G.S. § 133-32* and Executive Order 24 prohibit the offer to, or acceptance by, any State Employee of any gift from anyone with a contract with the State, or from any person seeking to do business with the State. By execution of any response in this procurement, you attest, for your entire organization and its employees or agents, that you are not aware that any such gift has been offered, accepted, or promised by any employees of your organization.

**SIGNATURE OF CONTRACTOR**

Name of Contractor \_\_\_\_\_  
Print or type Individual name

\_\_\_\_\_  
Address as Prequalified

\_\_\_\_\_  
Signature of Contractor, Individually

\_\_\_\_\_  
Print or type Signer's Name

\_\_\_\_\_  
Signature of Witness

\_\_\_\_\_  
Print or type Signer's name

**AFFIDAVIT MUST BE NOTARIZED**

Subscribed and sworn to before me this the \_\_\_\_\_  
\_\_\_\_\_ day of \_\_\_\_\_ 20\_\_.

**NOTARY SEAL**

\_\_\_\_\_  
Signature of Notary Public

of \_\_\_\_\_ County

State of \_\_\_\_\_

My Commission Expires: \_\_\_\_\_



## DEBARMENT CERTIFICATION

Conditions for certification:

1. The prequalified bidder shall provide immediate written notice to the Department if at any time the bidder learns that his certification was erroneous when he submitted his debarment certification or explanation filed with the Department, or has become erroneous because of changed circumstances.
2. The terms *covered transaction*, *debarred*, *suspended*, *ineligible*, *lower tier covered transaction*, *participant*, *person*, *primary covered transaction*, *principal*, *proposal*, and *voluntarily excluded*, as used in this provision, have the meanings set out in the Definitions and Coverage sections of the rules implementing Executive Order 12549. A copy of the Federal Rules requiring this certification and detailing the definitions and coverages may be obtained from the Contract Officer of the Department.
3. The prequalified bidder agrees by submitting this form, that he will not knowingly enter into any lower tier covered transaction with a person who is debarred, suspended, declared ineligible, or voluntarily excluded from participation in NCDOT contracts, unless authorized by the Department.
4. For Federal Aid projects, the prequalified bidder further agrees that by submitting this form he will include the Federal-Aid Provision titled *Required Contract Provisions Federal-Aid Construction Contract (Form FHWA PR 1273)* provided by the Department, without subsequent modification, in all lower tier covered transactions.
5. The prequalified bidder may rely upon a certification of a participant in a lower tier covered transaction that he is not debarred, suspended, ineligible, or voluntarily excluded from the covered transaction, unless he knows that the certification is erroneous. The bidder may decide the method and frequency by which he will determine the eligibility of his subcontractors.
6. Nothing contained in the foregoing shall be construed to require establishment of a system of records in order to render in good faith the certification required by this provision. The knowledge and information of a participant is not required to exceed that which is normally possessed by a prudent person in the ordinary course of business dealings.
7. Except as authorized in paragraph 6 herein, the Department may terminate any contract if the bidder knowingly enters into a lower tier covered transaction with a person who is suspended, debarred, ineligible, or voluntarily excluded from participation in this transaction, in addition to other remedies available by the Federal Government.

## DEBARMENT CERTIFICATION

The prequalified bidder certifies to the best of his knowledge and belief, that he and his principals:

- a. Are not presently debarred, suspended, proposed for debarment, declared ineligible, or voluntarily excluded from covered transactions by any Federal department or agency;
- b. Have not within a three-year period preceding this proposal been convicted of or had a civil judgment rendered against them for commission of fraud or a criminal offense in connection with obtaining, attempting to obtain, or performing a public (Federal, State or local) transaction or contract under a public transaction; violation of Federal or State antitrust statutes or commission of embezzlement, theft, forgery, bribery, falsification or destruction of records; making false statements; or receiving stolen property;
- c. Are not presently indicted for or otherwise criminally or civilly charged by a governmental entity (Federal, State or local) with commission of any of the offenses enumerated in paragraph b. of this certification; and
- d. Have not within a three-year period preceding this proposal had one or more public transactions (Federal, State or local) terminated for cause or default.
- e. Will submit a revised Debarment Certification immediately if his status changes and will show in his bid proposal an explanation for the change in status.

If the prequalified bidder cannot certify that he is not debarred, he shall provide an explanation with this submittal. An explanation will not necessarily result in denial of participation in a contract.

Failure to submit a non-collusion affidavit and debarment certification will result in the prequalified bidder's bid being considered non-responsive.

Check here if an explanation is attached to this certification.

# LETTER OF INTENT



LETTER OF INTENT TO PERFORM AS A SUBCONTRACTOR

CONTRACT:
-----------

NAME OF BIDDER:
-----------------

The undersigned intends to perform work in connection with the above contract upon execution of the bid and subsequent award of contract by the Board of Transportation as:

Name of MBE/WBE/DBE Subcontractor \_\_\_\_\_

Address \_\_\_\_\_

City \_\_\_\_\_ State \_\_\_\_\_ Zip \_\_\_\_\_

Please check all that apply:

Minority Business Enterprise (MBE) \_\_\_\_

Women Business Enterprise (WBE) \_\_\_\_

Disadvantaged Business Enterprise (DBE) \_\_\_\_

The MBE /WBE /DBE status of the above named subcontractor is certified by the North Carolina Department of Transportation. The above named subcontractor is prepared to perform the described work listed on the attached MBE/WBE/DBE Commitment Items sheet, in connection with the above contract upon execution of the bid and subsequent award of contract by the Board of Transportation. The above named subcontractor is prepared to perform the described work at the estimated Commitment Total for Subcontractor Price identified on the MBE/WBE/DBE Commitment Items sheet and amount indicated below.

Commitment Total based on estimated Unit Prices and Quantities on the "attached" MBE/WBE/DBE Commitment Items sheet. Amount \$ \_\_\_\_\_

The above named bidder and subcontractor mutually accepts the Commitment Total estimated for the Unit Prices and Quantities. This commitment total is based on estimated quantities only and most likely will vary up or down as the project is completed. Final compensation will be based on actual quantities of work performed and accepted during the pursuance of work. The above listed amount represents the entire dollar amount quoted based on these estimated quantities. No conversations, verbal agreements, and/or other forms of non-written representations shall serve to add, delete, or modify the terms as stated.

This document shall not serve in any manner as an actual subcontract between the two parties. A separate subcontractor agreement will describe in detail the contractual obligations of the bidder and the MBE/WBE/DBE subcontractor.

**Affirmation**

The above named MBE/ WBE/ DBE subcontractor affirms that it will perform the portion(s) of the contract for the estimated dollar value as stated above.

\_\_\_\_\_  
Name of MBE/ WBE/ DBE Subcontractor

\_\_\_\_\_  
Name of Bidder

\_\_\_\_\_  
Signature / Title

\_\_\_\_\_  
Signature / Title

\_\_\_\_\_  
Date

\_\_\_\_\_  
Date



**North Carolina Department of Transportation  
 BID FORM**

**WBS Element: 3B.101011/3B.201012**

**Project Description: Removal of Existing Pipe Culverts And  
 Replacement With Aluminum Pipe  
 Culverts And Headwalls.**

ITEM	DESC NO.	SECT	DESCRIPTION	QTY	UNIT	UNIT PRICE	AMOUNT BID
1	0000100000-N	800	MOBILIZATION	1	LS		
2	0063000000-N	SP	GRADING	1	LS		
3	0106000000-E	230	BORROW EXCAVATION	500	CY		
4	0318000000-E	300	FOUNDATION CONDITIONING MATERIAL - 57 STONE	3400	TON		
5	0992000000-E	SP	PIPE REMOVAL	6	EA		
6	1220000000-E	545	INCIDENTAL STONE BASE - ABC	750	TON		
7	1704000000-E	SP	ASPHALT PATCHING. TYPE I 19.OB	300	TON		
8	1704000000-E	SP	ASPHALT PATCHING TYPE SF 9.5A	420	TON		
9	2473000000-N	SP	PIPE & HEADWALL (ASSEMBLY & INSTALLATION)	6	EA		
10	3691000000-N	SP	DEWATERING	6	EA		
11	5882000000-N	SP	UTILITY RELOCATIONS	6	EA		
12	6000000000-E	1605	TEMPORARY SILT FENCE	3600	LF		
13	6009000000-E	1610	STONE FOR EROSION CONTROL -CLASS B	230	TON		
14	6036000000-E	1631	MATTING FOR EROSION CONTROL	450	SY		
15	6037000000-E	SP	COIR FIBER MAT	50	SY		
16	6071012000-E	SP	COIR FIBER WATTLE	450	LF		
17	6071020000-E	SP	POLYACRYLAMIDE (PAM)	12	LB		
18	6084000000-E	1660	SEEDING & MULCHING	1.5	ACR		

**TOTAL BID FOR PROJECT:** \_\_\_\_\_

CONTRACTOR \_\_\_\_\_

ADDRESS \_\_\_\_\_

Federal Identification Number \_\_\_\_\_

Contractors License Number \_\_\_\_\_

Authorized Agent \_\_\_\_\_ Title \_\_\_\_\_

Signature \_\_\_\_\_ Date \_\_\_\_\_

Witness \_\_\_\_\_ Title \_\_\_\_\_

Signature \_\_\_\_\_ Date \_\_\_\_\_

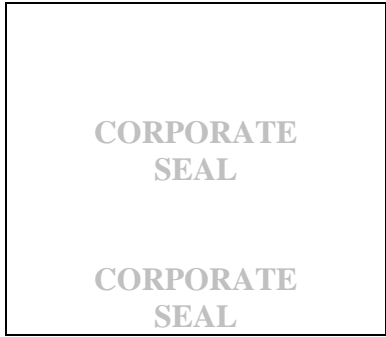

**THIS SECTION TO BE COMPLETED BY NORTH CAROLINA DEPARTMENT OF TRANSPORTATION**

*This bid has been reviewed in accordance with Article 103-1 of the Standard Specifications for Roads and Structures 2012.*

Reviewed by \_\_\_\_\_

Date \_\_\_\_\_

Accepted by \_\_\_\_\_

Date \_\_\_\_\_